



LED LUMINO



LED PROFILY



Sme obchodná spoločnosť zameraná na vývoj a predaj hliníkových profilov pre LED osvetlenie. V súčasnosti máme v ponuke viac ako 36 vlastných profilov a ďalšie nové typy sú vo vývoji.

Návrh, riešenie a výroba profilov je zameraná na dve dôležité vlastnosti profilu – funkčnosť a dizajn.

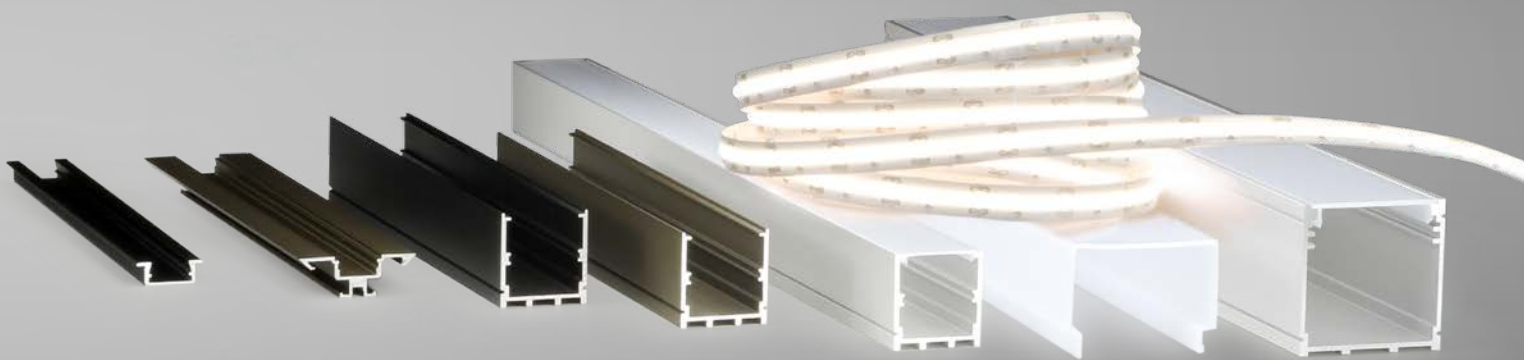

Funkčnosť

Hliník má dokonalé vlastnosti na odvod tepla a teda predlžuje životnosť LED pásov a zaručuje farebnú stálosť LED diód. Naše ALU profily sú eloxované a teda vhodné pre použitie s LED pásmi a elektrickými komponentmi, čím je zabezpečená ochrana proti skratu.

Dizajn

Všetky profily sa vyznačujú kvalitným spracovaním a svojim dizajnom vhodne dotvárajú priestor v ktorom sú použité. Kladieme vysoký dôraz na kvalitu spracovania a estetický výzor. Väčšinu profilov máme ako jeden z mála výrobcov eloxované v troch farebných vyhotoveniach – strieborná, bronzová, čierna a niektoré typy v práškových komaxitových farbách podľa RAL vzorkovníku a tieto profily vieme upraviť farebne aj podľa individuálnych požiadaviek zákazníka.

Naše profily sú vyrábané na Slovensku technológiou prietlačného lisovania za tepla zo zliatiny AW 6060 (EN 573-3) v mechanickom stave T66 (EN 755-2) pre meranie prierezových a tvarových charakteristík používame normu EN 755-9. Dosahujeme pevnosť v ťahu R_m min. 215MPa. Táto zliatina je upravená anodickou oxidáciou a hrúbka vrstvy dosahuje 15-20 mikrometrov.

Naším cieľom je poskytnutie najkvalitnejšieho a najširšieho sortimentu v ALU profiloch pre LED osvetlenie.

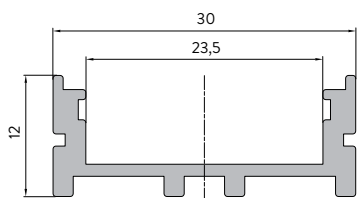

Tolerancie rozmerov podľa
EN 755-9

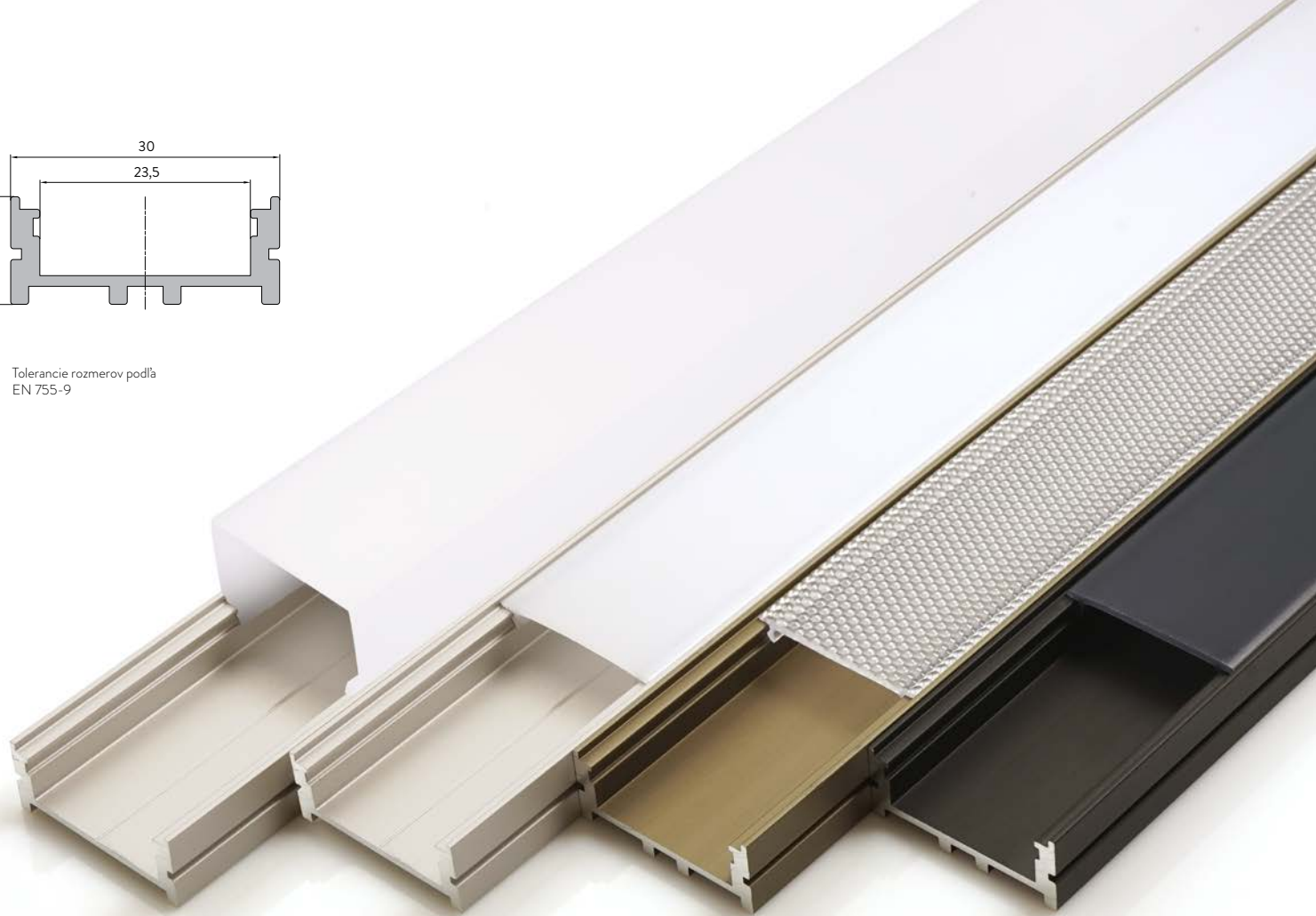

XC01

kód	názov	farba	max dĺžka (mm)	šírka (mm)	výška (mm)
80101	XC01	strieborný CO	4000	30	12
80102	BC01	bronzový C33	4000	30	12
80108	CC01	čierny C35	4000	30	12

■ povrchový profil

Difúzory

PC-N28-X-TRANSPARENT / OPAL
PC-N28-TRANSPARENT / OPAL / PRISMATIC / BLACK
PC-S28-OPAL

Doplňky

kód	názov	farba
85101	KONC-XC01	koncovka pre XC01 - zliatinová - našúvacia
86601	KLIP-XC01	klip pre profil XC01, XC19
851199	KONC-PL3D-BC01	koncovka pre BC01 - plastová - nasúvacia
851198	KONC-PL3D-CC01	koncovka pre CC01 - plastová - nasúvacia
881198	KONC-PL3D-XC01+S28	koncovka pre XC01 + S28 - plastová - nasúvacia
881198	KONC-PL3D-CC01+S28	koncovka pre CC01 + S28 - plastová - nasúvacia



85101



86601



851199



851198



85101



86601

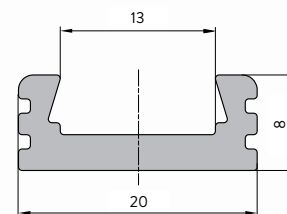
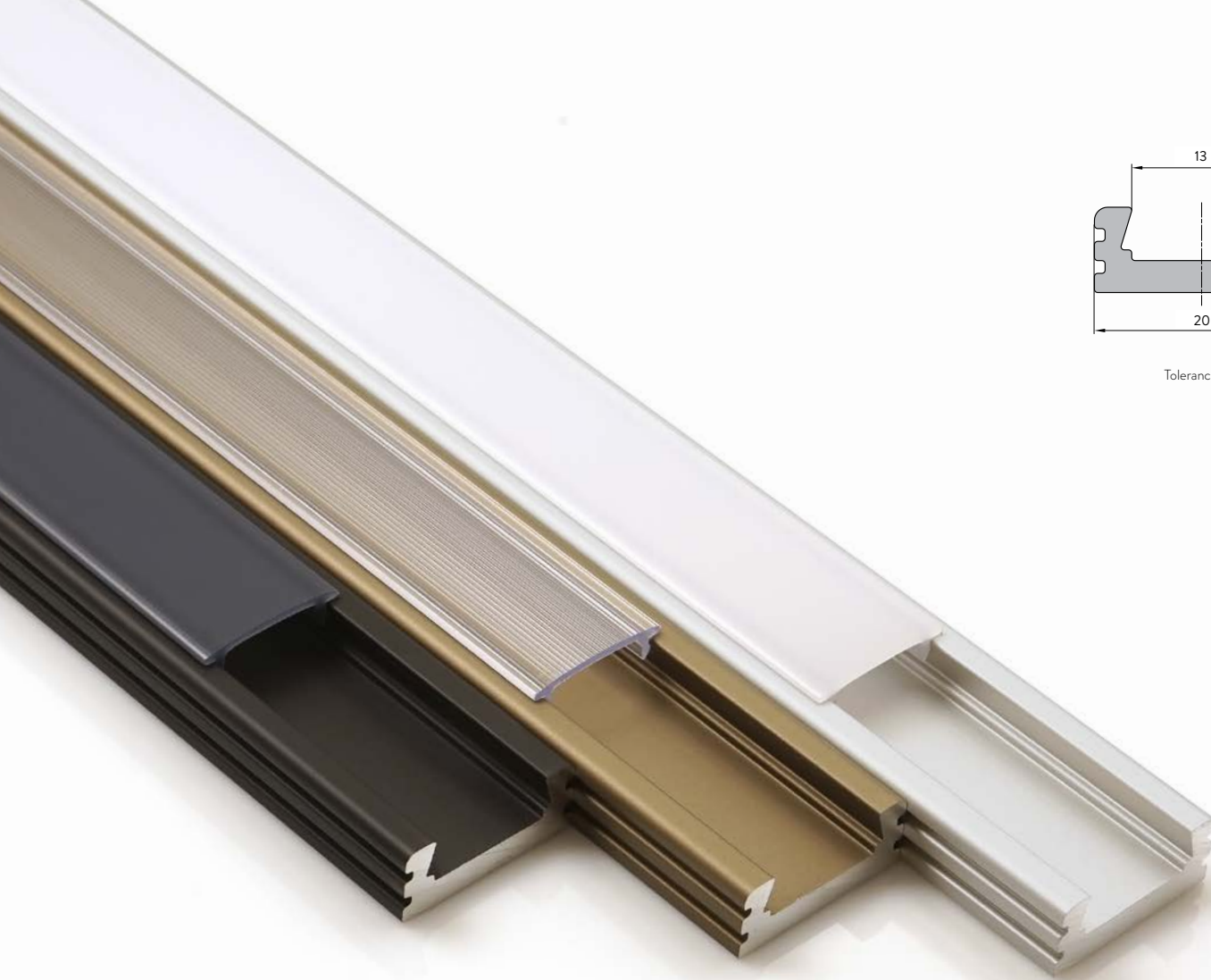

Tolerancie rozmerov podľa
EN 755-9

XC02

kód	názov	farba	max dĺžka (mm)	šírka (mm)	výška (mm)
80201	XC02	strieborný CO	4000	20	8
80202	BC02	bronzový C33	4000	20	8
80208	CC02	čierny C35	4000	20	8

■ povrchový profil

Difúzory

PC-N16-X-TRANSPARENT / OPAL
PC-N16-TRANSPARENT / OPAL / BLACK

Doplnky

kód	názov	farba
85201	KONC-XC02-S	koncovka pre XC02 - zliatinová - na skrutky
85202	KONC-BC02-S	koncovka pre BC02 - zliatinová - na skrutky
85207	KONC-XC02-PL	koncovka pre XC02 - plastová - nasúvacia



85201



85202



85207

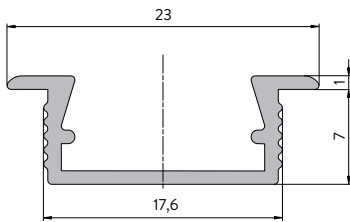

Tolerancie rozmerov podľa
EN 755-9

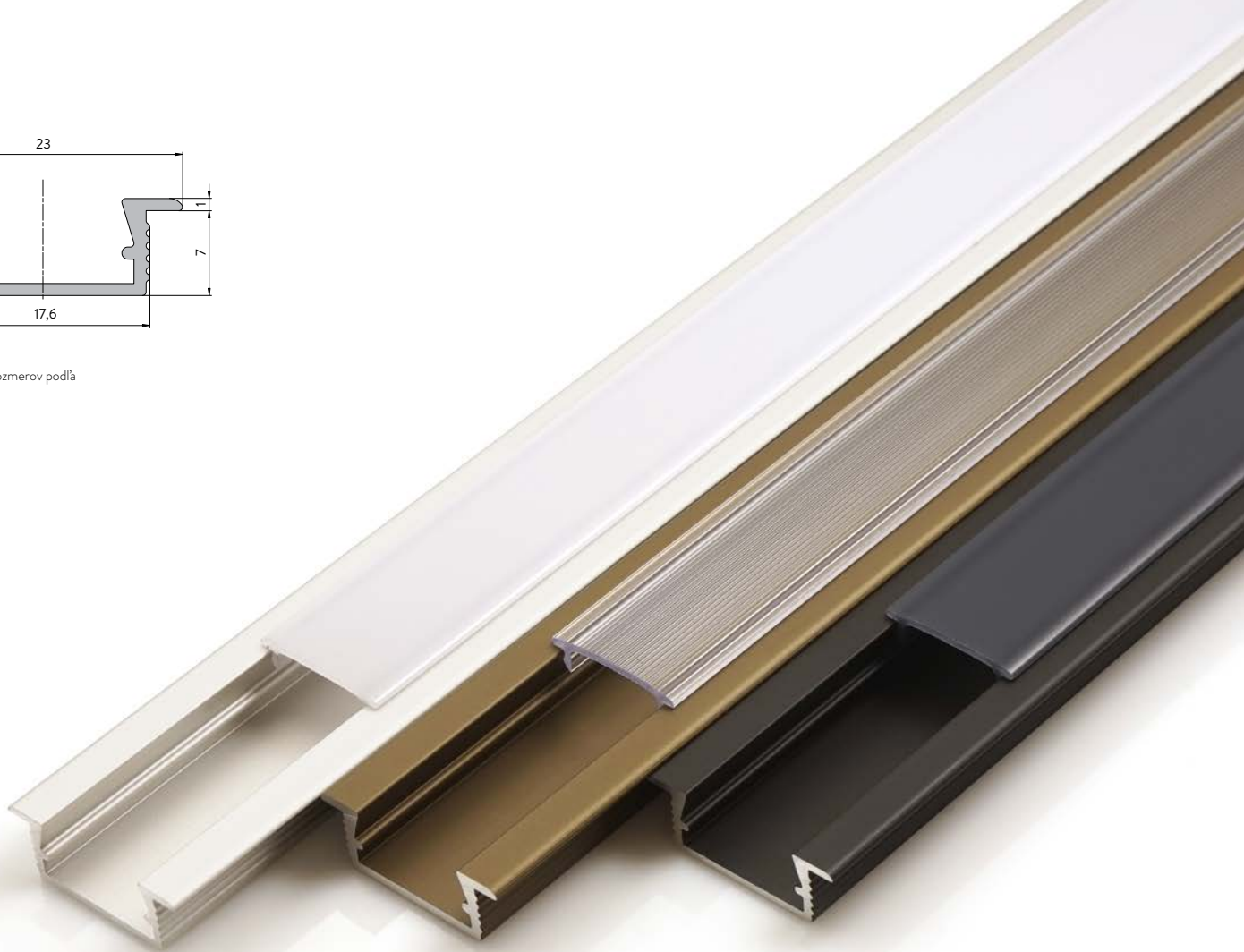

XC03

kód	názov	farba	max dĺžka (mm)	šírka (mm)	výška (mm)
80301	XC03	strieborný CO	4000	23	8
80302	BC03	bronzový C33	4000	23	8
80308	CC03	čierny C35	4000	23	8

■ zafrézovací profil, drážka 17,6 x 7 mm

Difúzory

PC-N16-X-TRANSPARENT / OPAL
PC-N16-TRANSPARENT / OPAL / BLACK

Doplňky

kód	názov	farba
85302	KONC-BC03	koncovka pre BC03 - plastová - nasúvacia
85307	KONC-XC03-PL	koncovka pre XC03 - plastová - nasúvacia
85607	KONC-CC03	koncovka pre CC03 - plastová - nasúvacia



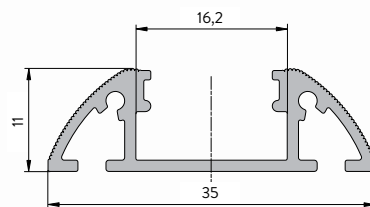

Tolerancie rozmerov podľa
EN 755-9

XC04

kód	názov	farba	max dĺžka (mm)	šírka (mm)	výška (mm)
80401	XC04	strieborný CO	4000	35	11
80402	BC04	bronzový C33	4000	35	11
80408	CC04	čierny C35	4000	35	11

■ povrchový oblúkový profil

Difúzory

PC-N16-X-TRANSPARENT / OPAL
PC-N16-TRANSPARENT / OPAL / BLACK

Doplňky

kód	názov	farba
85401	KONC-XC04	koncovka pre XC04 - zliatinová - nasúvacia
85402	KONC-BC04	koncovka pre BC04 - zliatinová - nasúvacia
85408	KONC-CC04	koncovka pre CC04 - zliatinová - nasúvacia
85507	KONC-XC04-PL	koncovka pre XC04 - plastová - nasúvacia



85401



85402



85408



85507

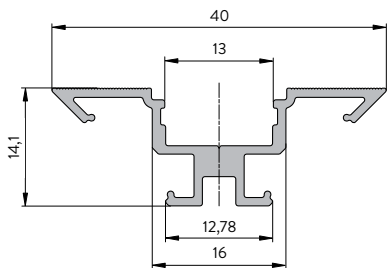

Tolerancie rozmerov podľa
EN 755-9

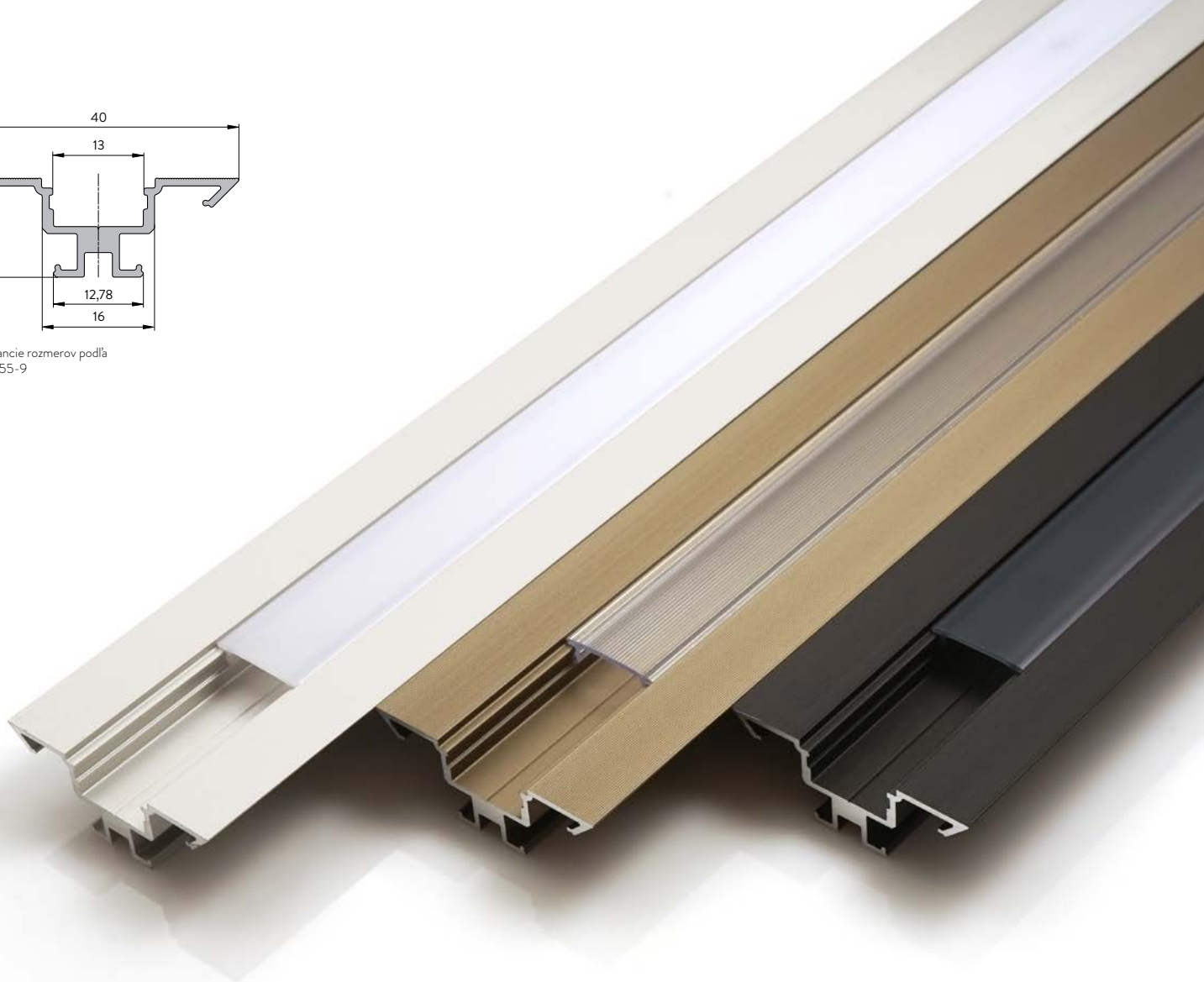

XC05

kód	názov	farba	max dĺžka (mm)	šírka (mm)	výška (mm)
80501	XC05	strieborný CO	4000	40	14
80502	BC05	bronzový C33	4000	40	14
80508	CC05	čierny C35	4000	40	14

■ rohový profil 45°

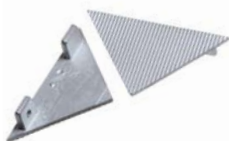

85501

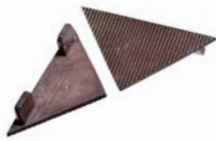

85502



85407



86401

Difúzory

PC-N16-X-TRANSPARENT / OPAL
PC-N16-TRANSPARENT / OPAL / BLACK

Doplňky

kód	názov	farba
85501	KONC-XC05	koncovka pre XC05 - zliatinová - nasúvacia
85502	KONC-BC05	koncovka pre BC05 - zliatinová - nasúvacia
85407	KONC-XC05-PL	koncovka pre XC05 - plastová - nasúvacia
86401	KLIP-XC05	klip pre profil XC05

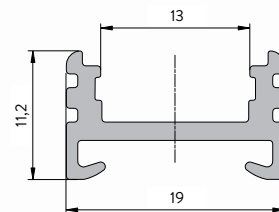
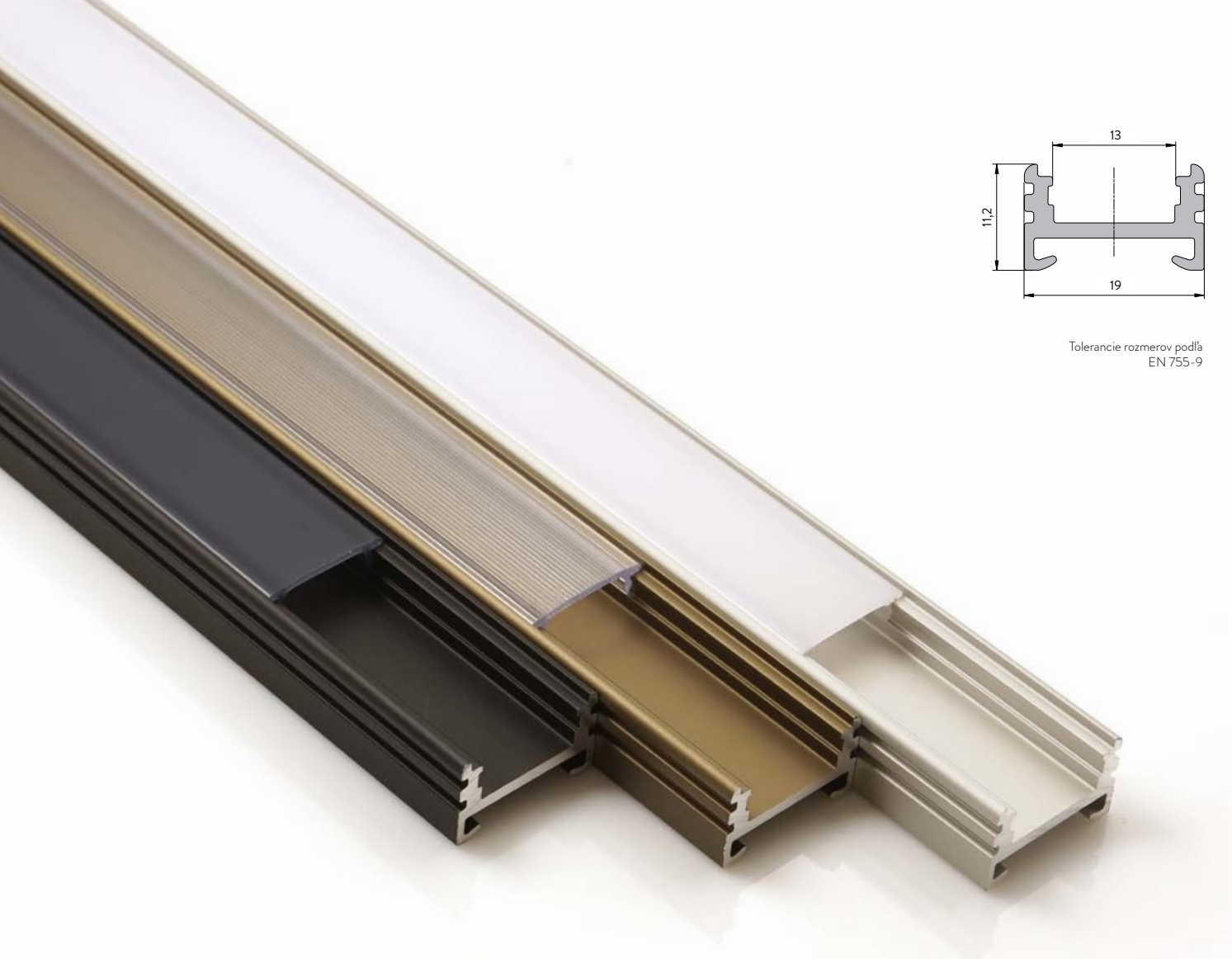

Tolerancie rozmerov podľa
EN 755-9

XC06

kód	názov	farba	max dĺžka (mm)	šírka (mm)	výška (mm)
80601	XC06	strieborný CO	4000	19	11,2
80602	BC06	bronzový C33	4000	19	11,2
80608	CC06	čierny C35	4000	19	11,2

■ povrchový profil

Difúzory

PC-N16-X-TRANSPARENT / OPAL
PC-N16-TRANSPARENT / OPAL / BLACK



85601



85602

Doplnky

kód	názov	farba
85601	KONC-XC06	koncovka pre XC06 - zliatinová - nasúvacia
85602	KONC-BC06	koncovka pre BC06 - zliatinová - nasúvacia
85608	KONC-CC06	koncovka pre CC06 - zliatinová - nasúvacia
86501	KLIP-XC06	klip pre profily XC06, 10,13



85608

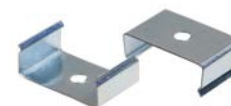

86501

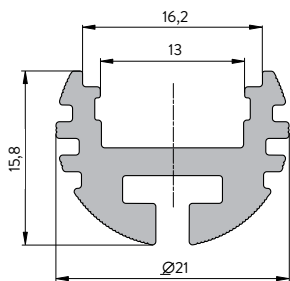

Tolerance rozmerov podľa
EN 755-9

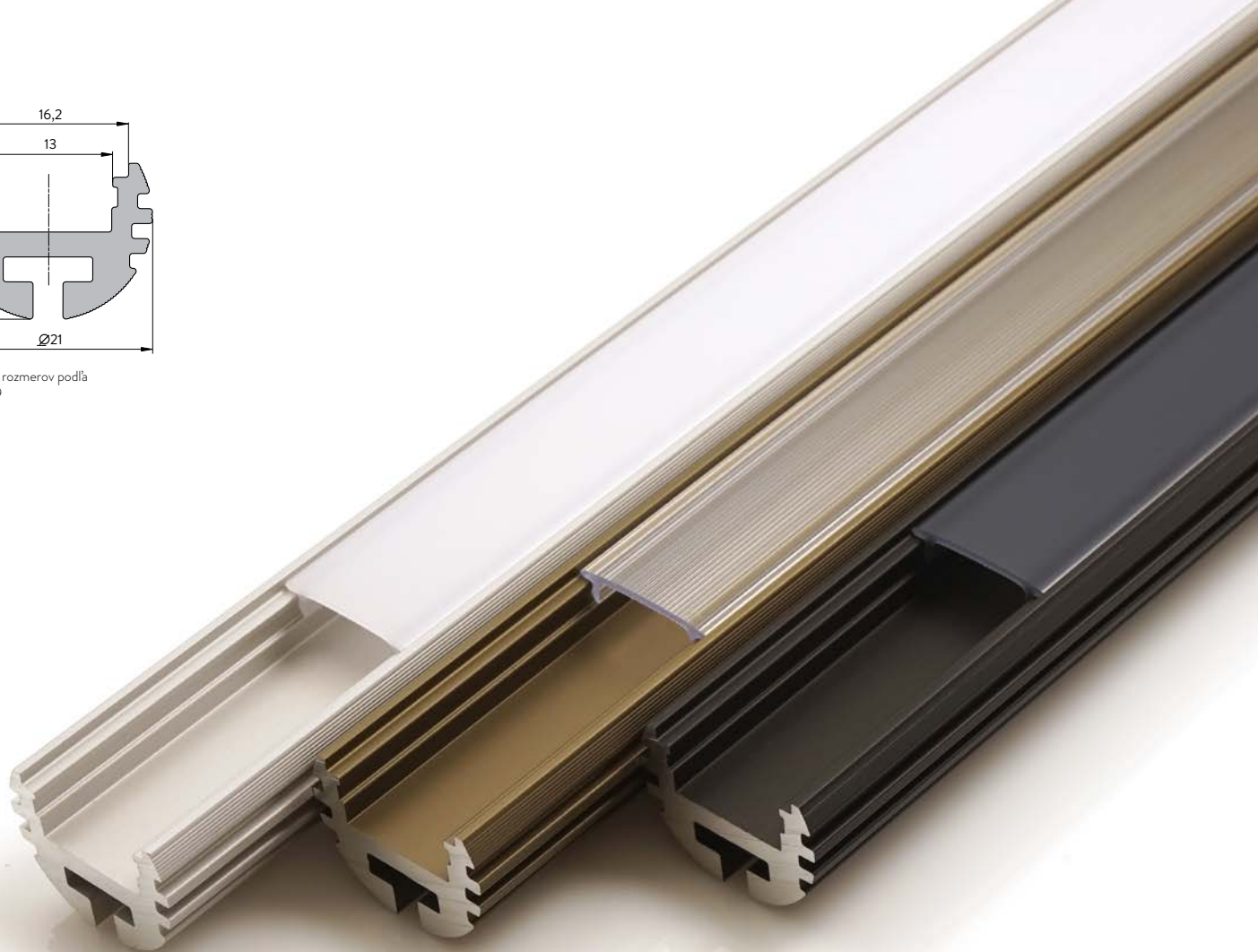

XC07



85701



86703



86803



87003



87004

kód	názov	farba	max dĺžka (mm)	šírka (mm)	výška (mm)
80701	XC07	strieborný CO	4000	21	15,8
80702	BC07	bronzový C33	4000	21	15,8
80708	CC07	čierny C35	4000	21	15,8

■ vešiaková tyč

Difúzory

PC-N16-X-TRANSPARENT / OPAL
PC-N16-TRANSPARENT / OPAL / BLACK

Doplňky

kód	názov	farba
85701	KONC-XC07	koncovka pre XC07 - zliatinová - nasúvacia
86703	BZ07	bočný záves pre profil XC07
86803	ZS07	stredný záves pre profil XC07
87003	KLB07-K	uhlový držiak nastaviteľný - krátky
87004	KLB07-D	uhlový držiak nastaviteľný - dlhý

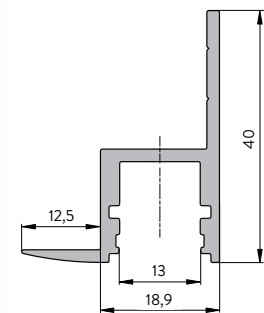

Tolerance rozmerov podľa EN 755-9

XC08

kód	názov	farba	max dĺžka (mm)	šírka (mm)	výška (mm)
80801	XC08	strieborný CO	4000	40	32,5

■ stenový profil – obvodová konštrukcia pre SDK

Difúzory

PC-N16-X-TRANSPARENT / OPAL
PC-N16-TRANSPARENT / OPAL / BLACK

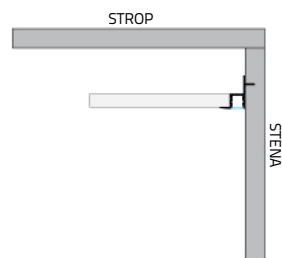

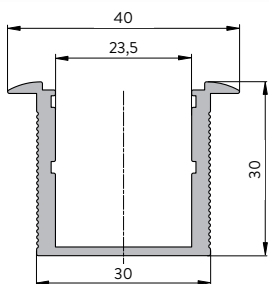

Tolerancie rozmerov podľa
EN 755-9

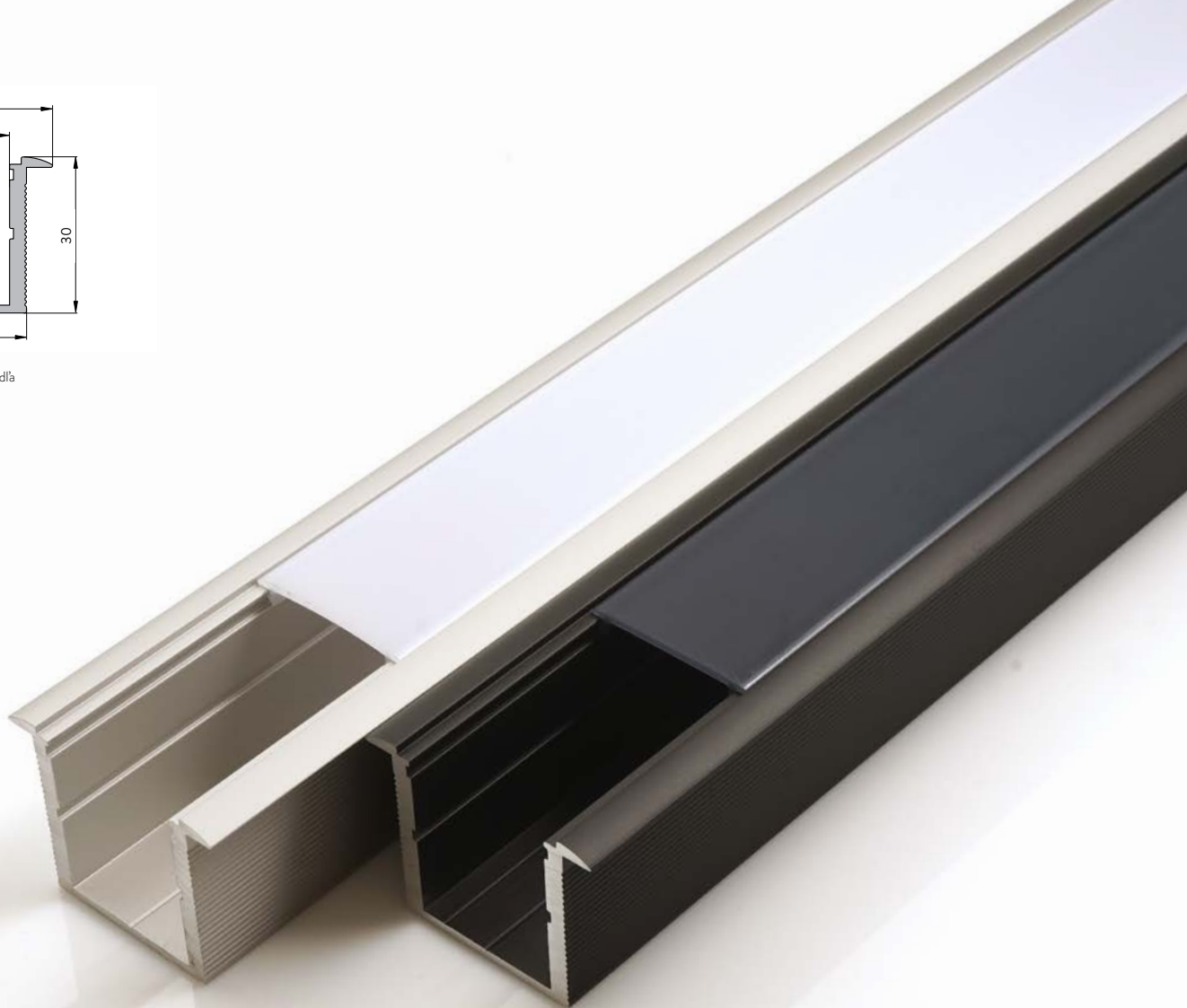

XC09

kód	názov	farba	max dĺžka (mm)	šírka (mm)	výška (mm)
80901	XC09	strieborný CO	4000	40	30
80908	CC09	čierny C35	4000	40	30

■ zápuštný profil do SDK

Difúzory

PC-N28-X-TRANSPARENT / OPAL
PC-N28-TRANSPARENT / OPAL / PRISMATIC / BLACK

Doplňky

kód	názov	farba
85901	KONC-XC09	koncovka pre XC09 - nasúvacia
851200	KONC-PL3D-CC09	koncovka PL3D-CC09 - plastová - nasúvacia
851201	KONC-PL3D-XC09	koncovka PL3D-XC09 - plastová - nasúvacia



85901



851200

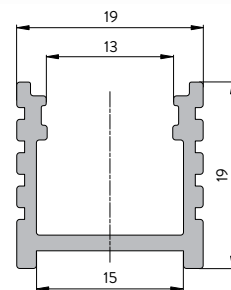
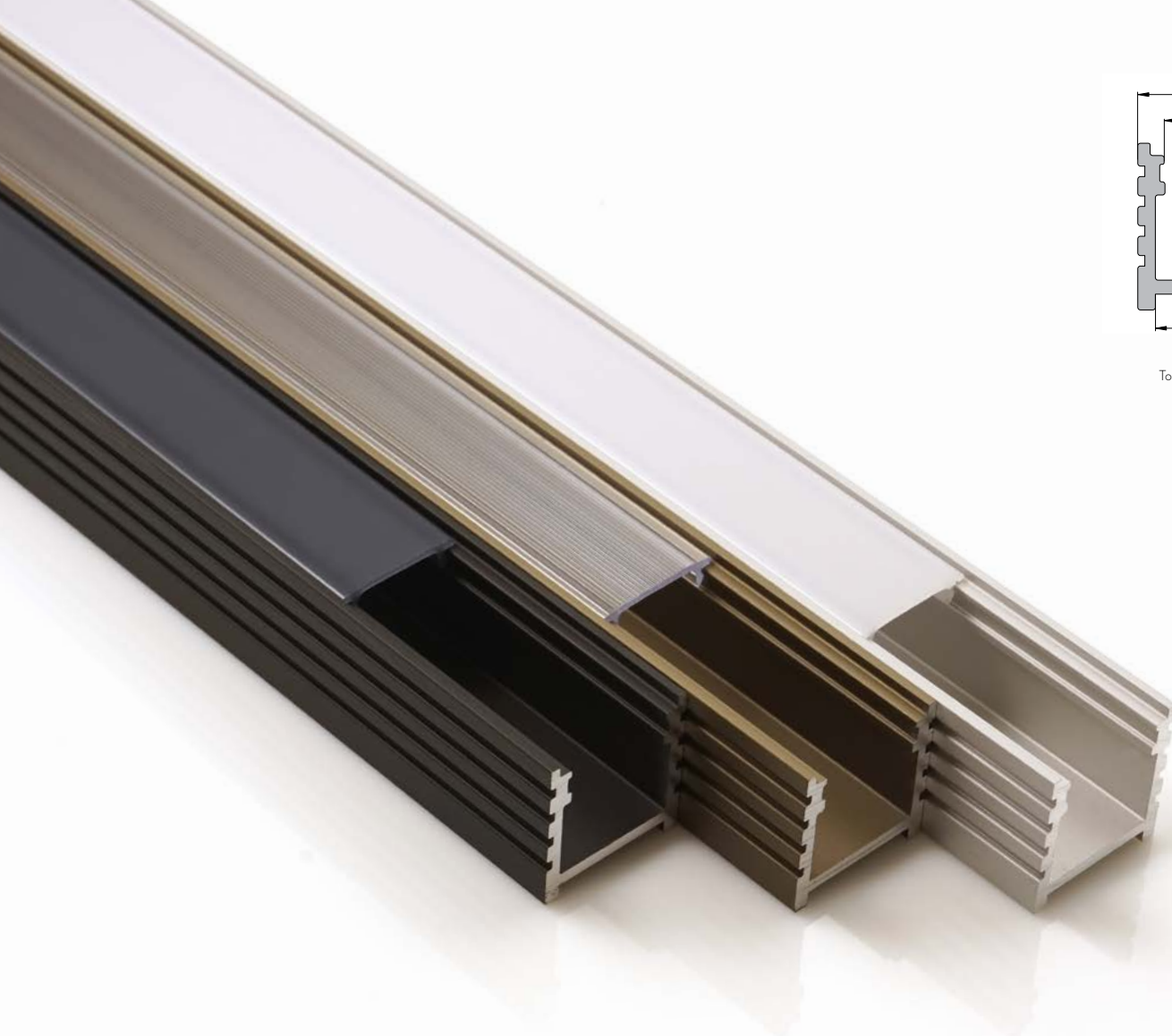

Tolerancie rozmerov podľa
EN 755-9

XC10

kód	názov	farba	max dĺžka (mm)	šírka (mm)	výška (mm)
81001	XC10	strieborný CO	4000	19	19
81002	BC10	bronzový C33	4000	19	19
81008	CC10	čierny C35	4000	19	19

■ povrchový profil

Difúzory

PC-N16-X-TRANSPARENT / OPAL
PC-N16-TRANSPARENT / OPAL / PRISMATIC / BLACK
PC-S16 OPAL

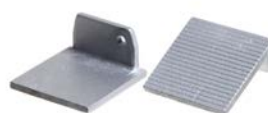

86001



86002

Doplňky

kód	názov	farba
86001	KONC-XC10	koncovka pre XC10 - zliatinová - nasúvacia
86002	KONC-BC10	koncovka pre BC10 - zliatinová - nasúvacia
86007	KONC-XC10-PL	koncovka pre XC10 - plastová - nasúvacia
86501	KLIP-XC06	klip pre profily XC06, 10, 13

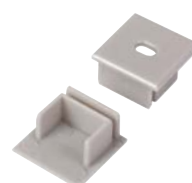

86007

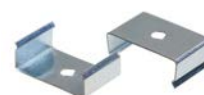

86501

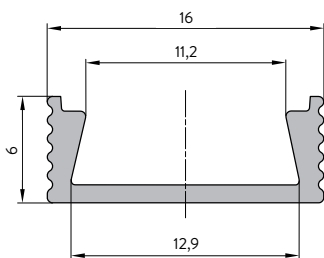

Tolerance rozmerov podľa
EN 755-9



XC11-Z

kód	názov	farba	max dĺžka (mm)	šírka (mm)	výška (mm)
81103	XC11-Z	strieborný CO	4000	16	6
81102	BC11-Z	bronzový C33	4000	16	6
81108	CC11-Z	čierny C35	4000	16	6

■ povrchový mikro profil

Difúzory

PC-N14-X-TRANSPARENT / OPAL
PC-N14-TRANSPARENT / OPAL / BLACK
PC-N14-30°-TRANSPARENT

Doplňky

kód	názov	farba
86107	KONC-XC11-PL	koncovka pre XC11 - nasúvacia - plastová



86107

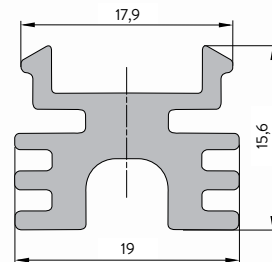

Tolerancie rozmerov podľa
EN 755-9

XC13

kód	názov	farba	max dĺžka (mm)	šírka (mm)	výška (mm)
81301	XC13	strieborný CO	4000	19	15,6

■ povrchový profil

Difúzory

PC-30°-SATIN / TRANSPARENT
PC-60°-SATIN / TRANSPARENT
PC-K18-OPAL / SATIN / TRANSPARENT



87501



87607

Doplňky

kód	názov	farba
87501	KONC-XC13	koncovka XC 13 - na skrutky
87607	KLIP-XC06	klip pre profily XC06, 10, 13
893004	BZ13	držiak profilu XC13
87004	KLB-13D	uhlový držiak nastaviteľný - dlhý



893004



87004

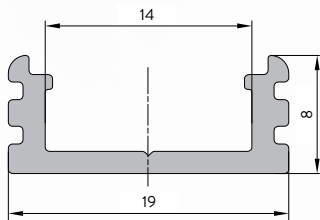

Tolerancie rozmerov podľa
EN 755-9

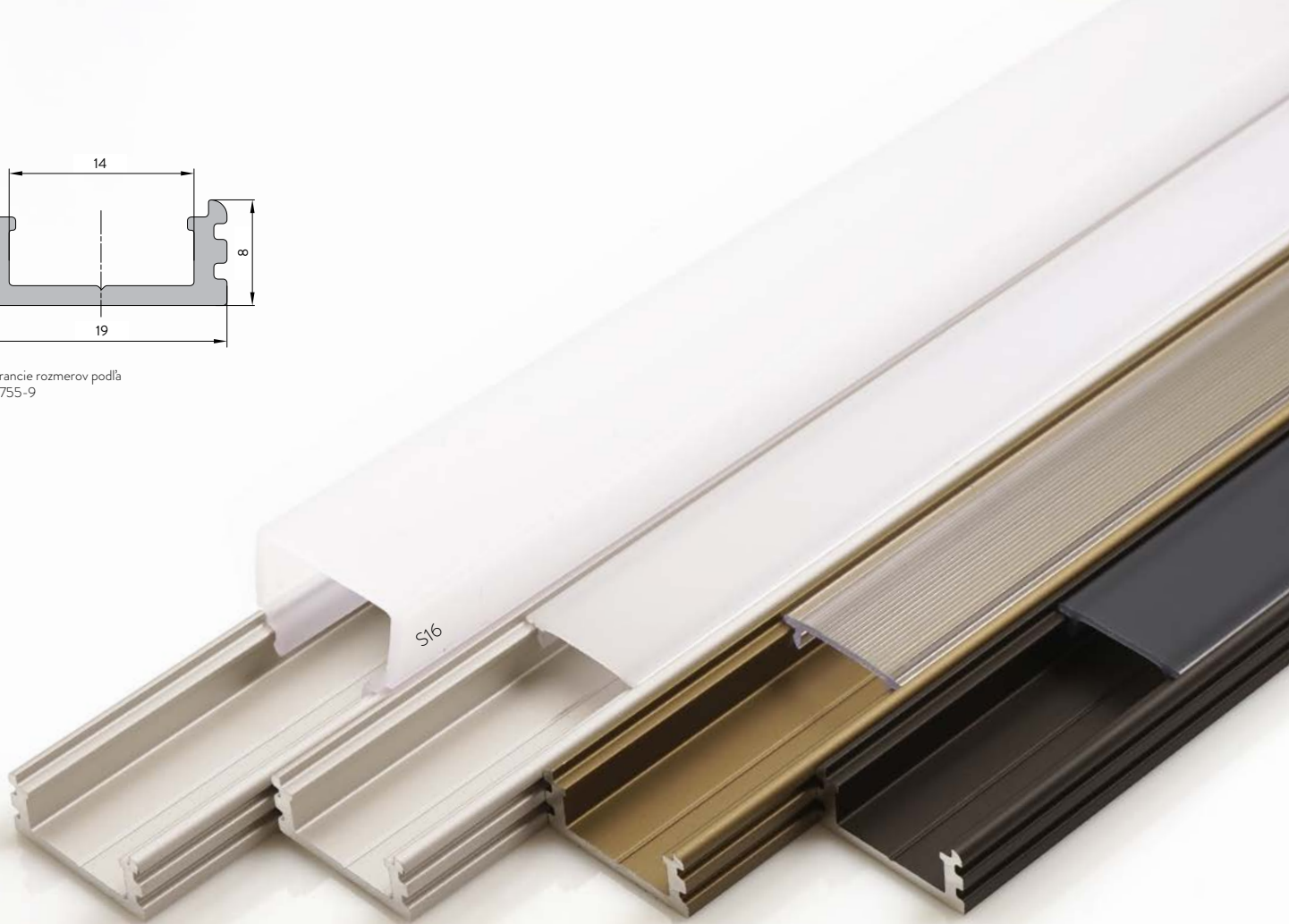

XC14



88207



88202

88209



87404



87408

■ povrchový profil

Difúzory

PC-N16-X-TRANSPARENT / OPAL
PC-N16-TRANSPARENT / OPAL / BLACK
PC-S16-OPAL

Doplňky

kód	názov	farba	max dĺžka (mm)	šírka (mm)	výška (mm)
81401	XC14	strieborný CO	4000	19	8
81402	BC14	bronzový C33	4000	19	8
81408	CC14	čierny C35	4000	19	8

kód	názov	farba
88207	KONC-XC14-PL	koncovka pre XC14 - nasúvacia - plastová
88202	KONC-BC14-AL	koncovka pre BC14 - zliatinová - nasúvacia
88209	KONC-CC14-AL	koncovka pre CC14 - zliatinová - nasúvacia
87404	KLIP-XC14	klip pre profily XC14, 23, 29
87408	KLIP-CC14	klip pre profily CC14, 23

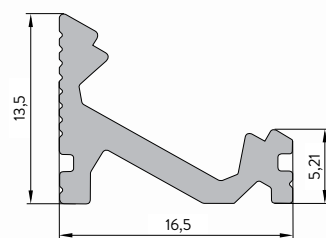
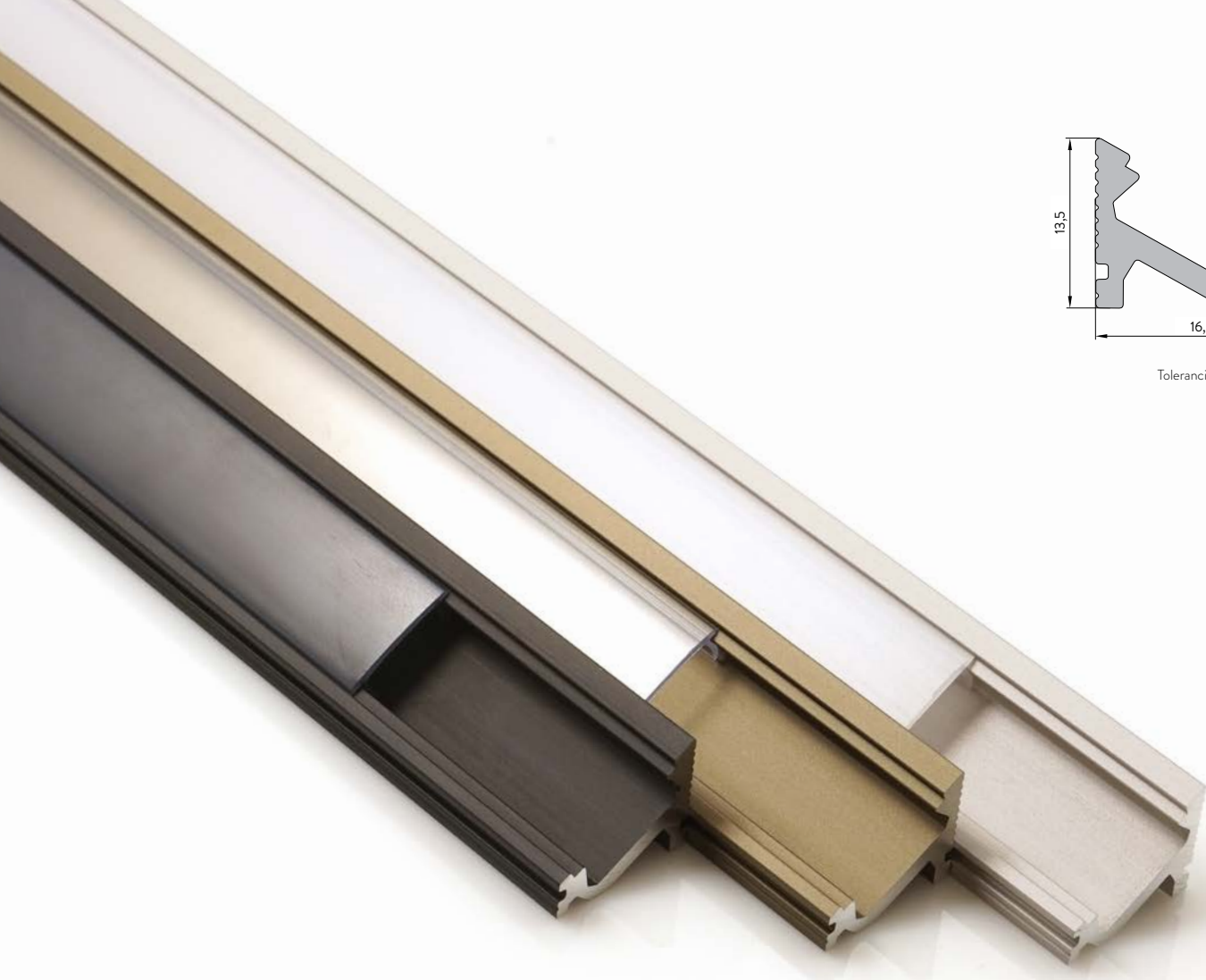

Tolerancie rozmerov podľa
EN 755-9

XC15 30°/60°

kód	názov	farba	max dĺžka (mm)	šírka (mm)	výška (mm)
81701	XC15	strieborný CO	4000	16,5	13,5
81702	BC15	bronzový C33	4000	16,5	13,5
81708	CC15	čierny C35	4000	16,5	13,5

■ rohový profil 30° / 60°

Difúzory

PC-N14-X-TRANSPARENT / OPAL
PC-N14-TRANSPARENT / OPAL / BLACK

Doplňky

kód	názov	farba
88203	KONC-XC15 30°/60°	koncovka pre XC15 - zliatinová - nasúvacia
85203	KONC-BC15 30°/60°	koncovka pre BC15 - zliatinová - nasúvacia
88206	KONC-CC15 30°/60°	koncovka pre CC15 - zliatinová - nasúvacia
881507	KONC-XC15-PL	koncovka pre XC15 - plastová - nasúvacia
87903	KLIP-XC15 30°/60°	klip pre profil XC15 30°/60°

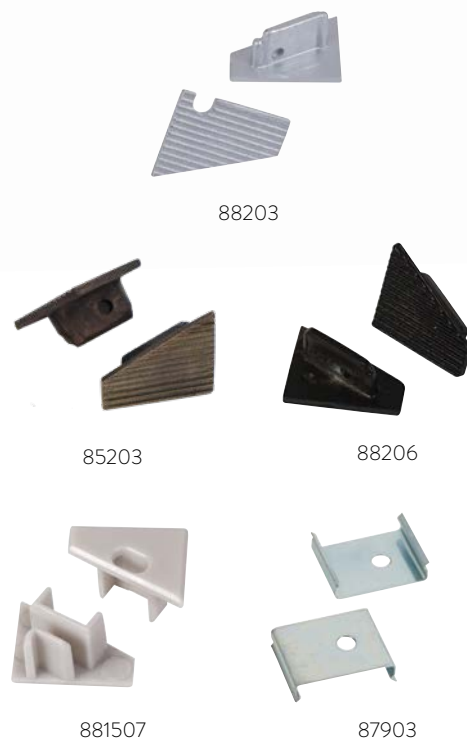

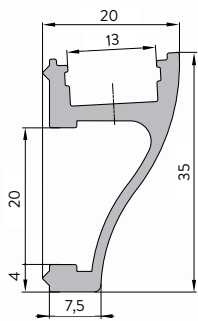

Tolerancie rozměrov podľa
EN 755-9

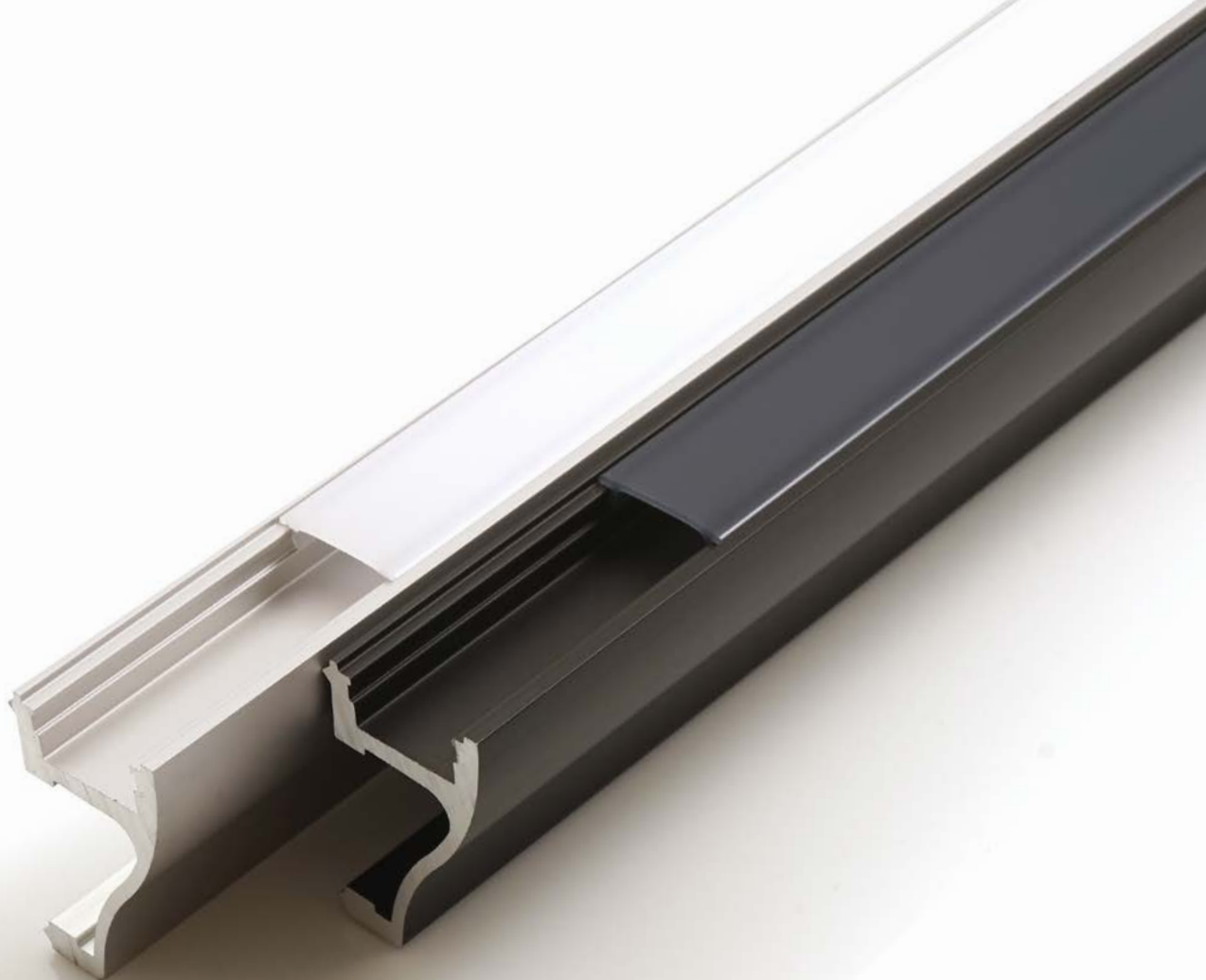

XC16

kód	názov	farba	max dĺžka (mm)	šírka (mm)	výška (mm)
82001	XC16	strieborný CO	4000	35	20
82008	CC16	čierny C35	4000	35	20

■ prisadený stenový profil



87701



87898

87899

Difúzory

PC-N16-X-TRANSPARENT / OPAL
PC-N16-TRANSPARENT / OPAL / BLACK

Doplňky

kód	názov	farba
87701	KLIP16	klip pre profil XC16
87898	KONC-PL3D-XC16	koncovka pre XC16 - plastová - nasúvacia
87899	KONC-PL3D-CC16	koncovka pre XC16 - plastová - nasúvacia

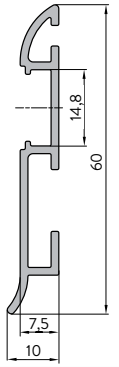

Tolerance rozmerov podľa
EN 755-9

XC17

kód	názov	farba	max dĺžka (mm)	šírka (mm)	výška (mm)
82301	XC17	strieborný CO	4000	60	10
82308	CC17	čierny C35	4000	60	10

■ soklová lišta pre LED

Difúzory

PC-N16-X-TRANSPARENT / OPAL
PC-N16-TRANSPARENT / OPAL / BLACK

Doplňky

kód	názov	farba
884998	KONC-PL3D-XC17	koncovka pre XC17 (L,P) - plastová - nasúvacia
884998	KONC-PL3D-CC17	koncovka pre XC17 (L,P) - plastová - nasúvacia



884998



884999

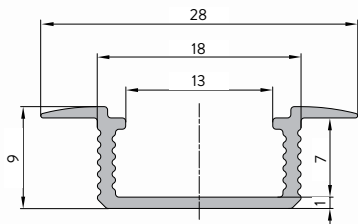

Tolerancie rozmerov podľa
EN 755-9

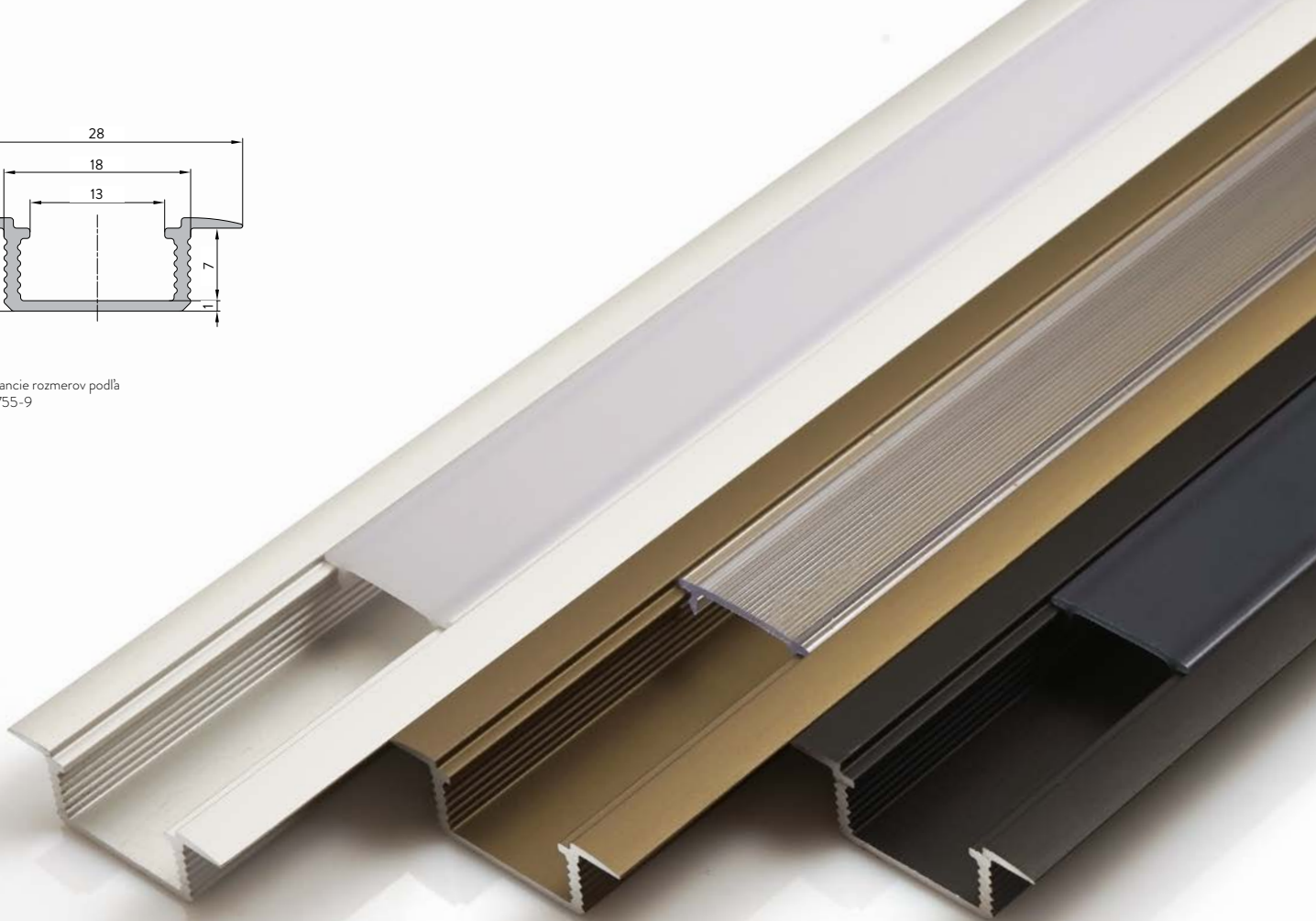

XC18

kód	názov	farba	max dĺžka (mm)	šírka (mm)	výška (mm)
81801	XC18	strieborný CO	4000	28	9
81802	BC18	bronzový C33	4000	28	9
81808	CC18	čierny C35	4000	28	9

■ zafrézovací profil – drážka 18 x 8,2mm



Difúzory

PC-N16-X-TRANSPARENT / OPAL
PC-N16-TRANSPARENT / OPAL / BLACK

Doplňky

kód	názov	farba
87907	KONC-XC18-PL	koncovka pre XC18 - plastová - nasúvacia
87901	KONC-XC18-O-AL	koncovka XC 18 - zliatinová - nasúvacia
87902	KONC-BC18-O-AL	koncovka BC 18 - zliatinová - nasúvacia

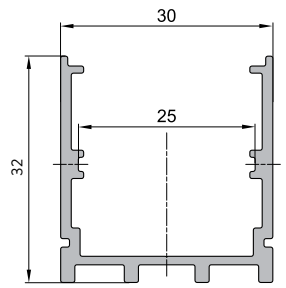
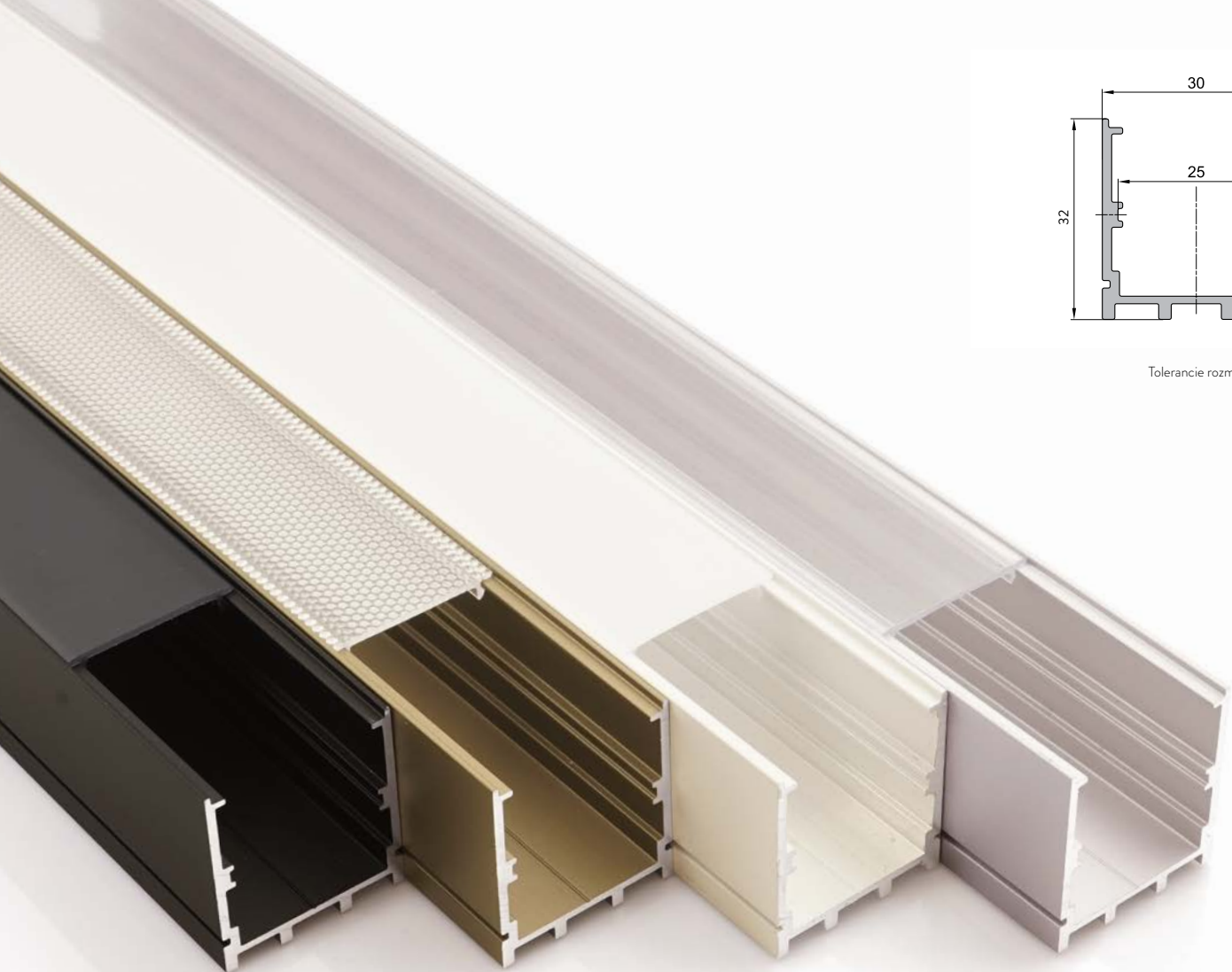

Tolerancie rozmerov podľa
EN 755-9

XC19

kód	názov	farba	max dĺžka (mm)	šírka (mm)	výška (mm)
82101	XC19	strieborný CO	4000	30	32
82102	BC19	bronzový C33	4000	30	32
82108	CC19	čierny C35	4000	30	32
82105	XW19	biela RAL 9003	4000	30	32

■ povrchový profil

Difúzory

PC-N28-X-TRANSPARENT / OPAL
PC-N28-TRANSPARENT / OPAL / PRISMATIC / BLACK

Doplňky

kód	názov	farba
88301	KONC-XC19	koncovka pre XC19 - zliatinová - nasúvacia
88308	KONC-CC19	koncovka pre CC19 - zliatinová - nasúvacia
88391	KONC-PL3D-XC19	koncovka pre XC19 - plastová - nasúvacia
88398	KONC-PL3D-CC19	koncovka pre CC19 - plastová - nasúvacia
88596	KONC-PL3D-XW19	koncovka pre XW19 - plastová - nasúvacia
86601	KLIP-XC01	klip pre profily XC01,19

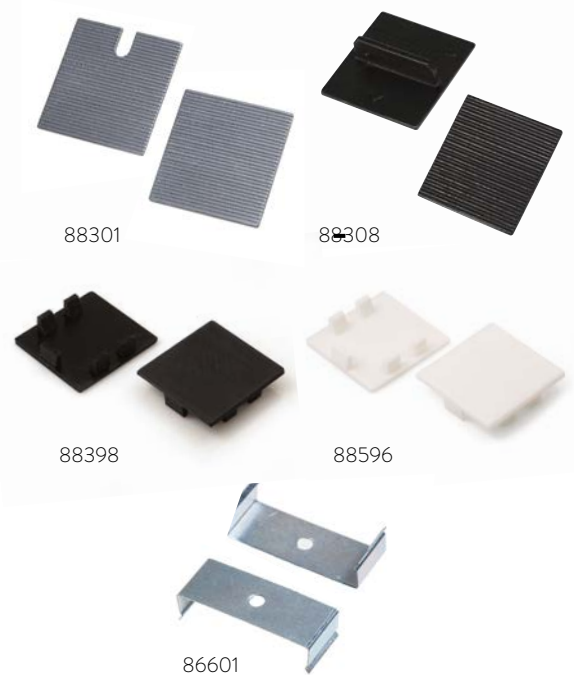



88302



88302

Difúzor

PC-S28 OPAL

Doplňky

kód	názov	farba
88302	KONC-PL3D-XC19-S28	koncovka pre XC19+S28 - kovová - nasúvacia
88303	KONC-PL3D-CC19-S28	koncovka pre CC19+S28 - plastová - nasúvacia
86601	KLIP-XC01	klip pre profily XC01,19

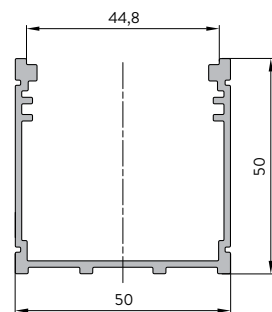

Tolerancie rozmerov podľa EN 755-9

XC21

kód	názov	farba	max dĺžka (mm)	šírka (mm)	výška (mm)
82801	XC21	strieborný CO	4000	50	50
82808	CC21	čierny C35	4000	50	50
82805	XW21	biela RAL9003	4000	50	50

■ povrchový profil



88599



88598

88595



85001



85008

Difúzory

PC-N44-TRANSPARENT / OPAL / PRISMATIC

Doplňky

kód	názov	farba
88599	KONC-PL3D-XC21	koncovka pre XC21 - plastová - nasúvacia
88598	KONC-PL3D-CC21	koncovka pre CC21 - plastová - nasúvacia
88595	KONC-PL3D-XW21	koncovka pre XW21 - plastová - nasúvacia
85001	KLIP XC21	klip pre profil XC 21
85008	KLIP CC21	klip pre profil CC 21



Difúzor

S44-OPAL

Doplňky

kód	názov	farba
88599	KONC-PL3D-XC21+S44	koncovka XC 21 - nasúvacia
88598	KONC-PL3D-CC21+S44	koncovka CC 21 - nasúvacia
88595	KONC-PL3D-XW21+S44	koncovka WC 21 - nasúvacia
85001	KLIP XC21	klip pre profil XC 21
85008	KLIP CC21	klip pre profil CC 21

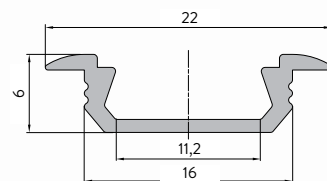
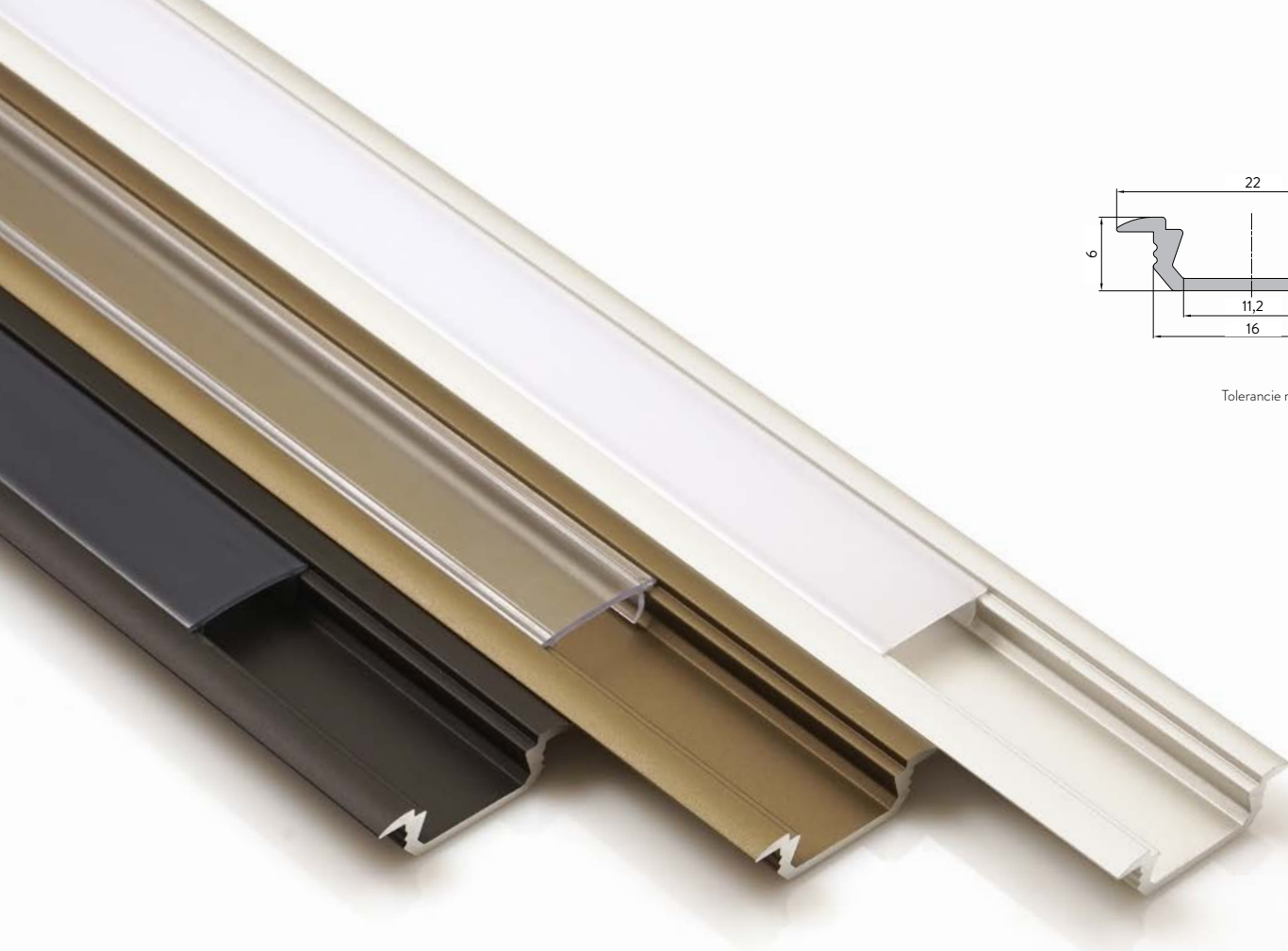

Tolerancie rozmerov podľa
EN 755-9

XC22

kód	názov	farba	max dĺžka (mm)	šírka (mm)	výška (mm)
83001	XC22	strieborný CO	4000	22	6
83002	CC22	čierny C35	4000	22	6
83003	BC22	bronzová C33	4000	22	6

■ zafrézovací profil, drážka 16 x 5,5 mm

Difúzory

PC-N14-X-TRANSPARENT / OPAL
PC-N14-TRANSPARENT / OPAL / BLACK

Doplňky

kód	názov	farba
88607	KONC-XC22-O-PL	koncovka pre XC22 - plastová - nasúvacia
87405	KLIP-CC14	klip pre profily XC14,23



88607

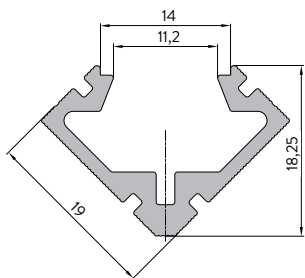

Tolerance rozmerov podľa
EN 755-9



XC23

kód	názov	farba	max dĺžka (mm)	šírka (mm)	výška (mm)
81701	XC23	strieborný CO	4000	19	19
81702	BC23	bronzový C33	4000	19	19
81708	CC23	čierny C35	4000	19	19

■ rohový profil 45°

Difúzory

PC-N14-X-TRANSPARENT / OPAL
PC-N14-TRANSPARENT / OPAL / BLACK

Doplňky

kód	názov	farba
87507	KONC-XC23-PL	koncovka pre XC23 - plastová - nasúvacia
87404	KLIP-XC14	klip pre profily XC14,23
87405	KLIP-CC14	klip pre profily XC14,23



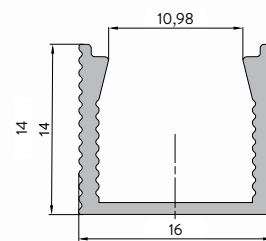

Tolerancie rozmerov podľa
EN 755-9

XC25

kód	názov	farba	max dĺžka (mm)	šírka (mm)	výška (mm)
83301	XC25	strieborný CO	4000	16	14
83308	CC25	čierny C35	4000	16	14

■ povrchový profil

Difúzory

PC-N14-X-TRANSPARENT / OPAL
PC-N14-TRANSPARENT / OPAL / BLACK

Doplňky



88701

kód	názov	farba
88701	KONC-XC25	koncovka pre XC25 - zliatinová - nasúvacia

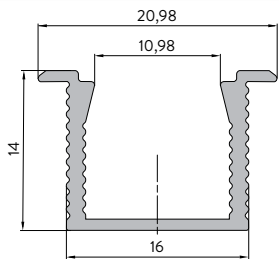

Tolerancie rozmerov podľa
EN 755-9



XC26

kód	názov	farba	max dĺžka (mm)	šírka (mm)	výška (mm)
83401	XC26	strieborný CO	4000	21	14

■ povrchový profil



88801

Difúzory

PC-N14-X-TRANSPARENT / OPAL
PC-N14-TRANSPARENT / OPAL / BLACK

Doplňky

kód	názov	farba
88801	KONC-XC26	koncovka pre XC26 - zliatinová - nasúvacia

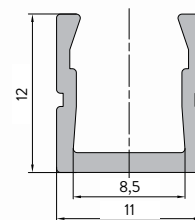

Tolerancie rozmerov podľa
EN 755-9

XC27

kód	názov	farba	max dĺžka (mm)	šírka (mm)	výška (mm)
83501	XC27	strieborný CO	4000	11	12
83508	CC27	čierny C35	4000	11	12

■ povrchový profil

Difúzory

PC-N11-OPAL

Doplňky



88901

kód	názov	farba
88901	KONC-XC27	koncovka pre XC27 - zliatinová - nasúvacia

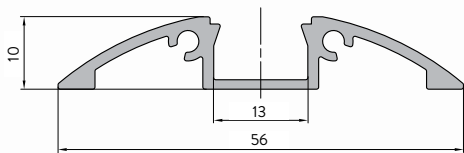

Tolerancie rozmerov podľa
EN 755-9



XC28

kód	názov	farba	max dĺžka (mm)	šírka (mm)	výška (mm)
83601	XC28	strieborný CO	4000	56	10
83602	BC28	bronzový C33	4000	56	10
83608	CC28	čierny C35	4000	56	10

■ povrchový profil

Difúzory

PC-N14-X-TRANSPARENT / OPAL
PC-N14-TRANSPARENT / OPAL / BLACK

Doplňky

kód	názov	farba
89001	KONC-XC28	koncovka pre XC28 - zliatinová - nasúvacia
88600	KONC-PL3D-CC28	koncovka pre CC28 - zliatinová - nasúvacia



89001

88600

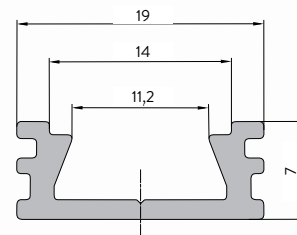

Tolerancie rozmerov podľa
EN 755-9

XC29

kód	názov	farba	max dĺžka (mm)	šírka (mm)	výška (mm)
83701	XC29	strieborný CO	4000	19	7,5

■ povrchový profil

Difúzory

PC-N14-X-TRANSPARENT / OPAL
PC-N14-TRANSPARENT / OPAL / BLACK

Doplňky

kód	názov	farba
89101	KONC-XC29	koncovka pre XC29 - zliatinová - nasúvacia
87404	KLIP-XC14	klip pre profily XC14,23,29



88701

88701

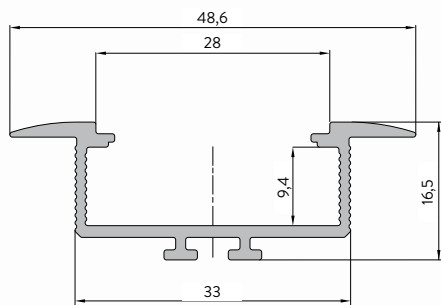

Tolerancie rozmerov podľa
EN 755-9

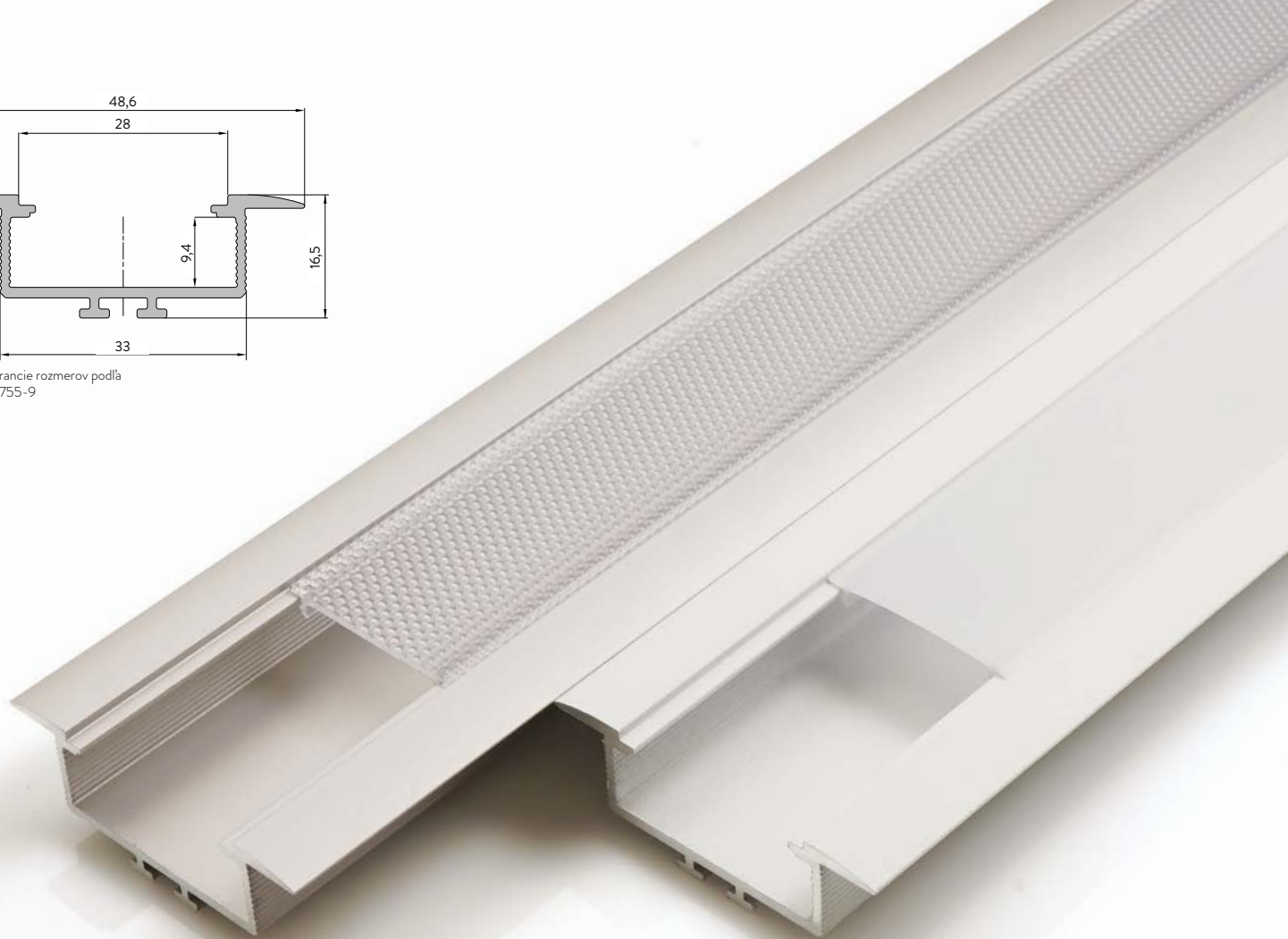

XC30

kód	názov	farba	max dĺžka (mm)	šírka (mm)	výška (mm)
83801	XC30	strieborný CO	4000	48,6	16,5
83805	XW30	biela RAL9003	4000	48,6	16,5

■ zápuštný profil do SDK



88595

Difúzory

PC-N28-X TRANSPARENT / OPAL
PC-N28-TRANSPARENT / OPAL / PRISMATIC / BLACK
PC-S28-OPAL

Doplňky

kód	názov	farba
810201	KLIP-XC30	pružina XC 30
842007	KONC-PL3D-XC30	koncovka pre CC21 - plastová - nasúvacia
892008	KONC-PL3D-XW30	koncovka pre WC21 - plastová - nasúvacia



842007

892008

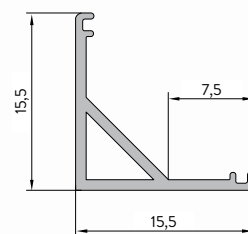

Tolerancie rozmerov podľa
EN 755-9

XC31

kód	názov	farba	max dĺžka (mm)	šírka (mm)	výška (mm)
83901	XC31	strieborný CO	2000	16	16

■ rohový profil 45°

Difúzory

PC-K31-SATIN / OPAL
PC-S31-SATIN / OPAL



891007

891008

Doplnky

kód	názov	farba
891007	KONC-XC31-K	koncovka pre XC31 pre PC-K31 - plastová nasúvacia
891008	KONC-XC31-S	koncovka pre XC31 pre PC-S31 - plastová nasúvacia
811201	KLIP-XC31	klip XC 31



811201

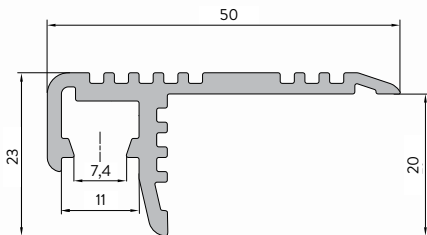

Tolerancie rozmerov podľa
EN 755-9



XC32



kód	názov	farba	max dĺžka (mm)	šírka (mm)	výška (mm)
83911	XC32	strieborný CO	4000	50	23
83918	CC32	čierny C35	4000	50	23

■ schodiskový profil



Difúzory

PC-N11-OPAL

Doplňky

kód	názov	farba
893998	KONC-PL3D-XC32	koncovka pre XC32 - plastová nasúvacia
893999	KONC-PL3D-CC30	koncovka pre CC32 - plastová nasúvacia



ROPE - SS - SILVER - 2500

ROPE - SS - BLACK - 2500



MAGNET-SET

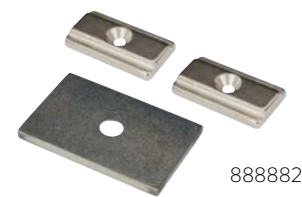

88882

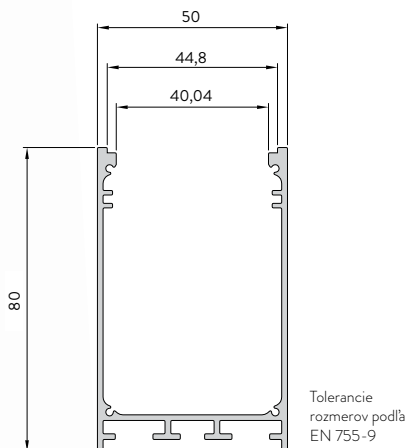

XC33

kód	názov	farba	max dĺžka (mm)	šírka (mm)	výška (mm)
83901	XC33	strieborný CO	4000	50	80
83902	BC33	bronzový C33	4000	50	80
83908	CC33	čierny C35	4000	50	80
83905	XW33	biely C35	4000	50	80

■ povrchový profil

Difúzory:

PC-N44-TRANSPARENT / OPAL / PRISMATIC
PC-S44-OPAL

Doplňky

kód	názov	farba
894091	KONC-PL3D-XC33	koncovka pre XC33
894098	KONC-PL3D-CC33	koncovka pre CC33
894092	KONC-PL3D-XC33 - S44	koncovka pre XC33 S44
894093	KONC-PL3D-XC33 - S44	koncovka pre CC33 S44
870000	ROPE-SS-SILVER-2500	lankový záves pre XC33 - 1ks
870002	ROPE-SS-BLACK-2500	lankový záves pre CC33 - 1ks
888882	MAGNET-SET	magnetický set pre uchytenie XC33,CC33-set

LED moduly

kód	názov	popis	max dĺžka (mm)	šírka (mm)	výška (mm)
143947	1,7W - 28RG42 - NW	MODUL	10,5 cm	CRI > 90	180 lm
142947	1,7W - 28RG42 - WW	MODUL	10,5 cm	CRI > 90	160 lm
143946	4,2W - 28RG42 - NW	MODUL	10,5 cm	CRI > 90	400 lm
142946	4,2W - 28RG42 - WW	MODUL	10,5 cm	CRI > 90	350 lm
143948	4,8W - 28RG120 - NW	MODUL	30 cm	CRI > 90	500 lm
142948	4,8W - 28RG120 - WW	MODUL	30 cm	CRI > 90	450 lm
143945	12W - 28RG120 - NW	MODUL	30 cm	CRI > 90	1050 lm
142945	12W - 28RG120 - WW	MODUL	30 cm	CRI > 90	1000 lm
148945	11W - 50RG48 - RGB	MODUL	30 cm	-	1800 mcd

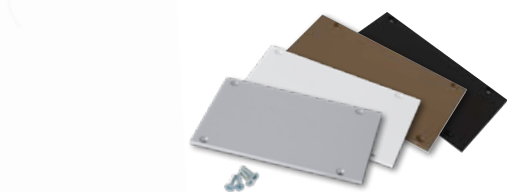

870002



870000



10,5 cm modul
NW (4050 - 4300K)
alebo WW (2800 - 3000K)



30 cm modul
NW (4050 - 4300K)
alebo WW (2800 - 3000K)



30 cm modul
RGB

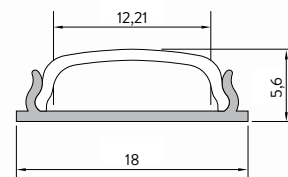

Tolerancie rozmerov podľa
EN 755-9

XC34



kód	názov	farba	max dĺžka (mm)	šírka (mm)	výška (mm)
84101	XC34	strieborný CO	2000	17,5	4

- flexibilný alu profil
- alu profil dodávaný iba s OPALovým difúzorom

Doplňky

kód	názov	farba
895001	KONC-XC34-PL	koncovka pre XC34 - plastová
812201	KLIP-XC34	klip XC 34



895001



812201

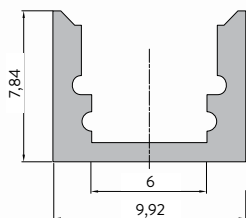

Tolerance rozmerov podľa
EN 755-9



XC35

kód	názov	farba	max dĺžka (mm)	šírka (mm)	výška (mm)
84201	XC35	strieborný CO	2000	9,92	7,84

■ alu profil dodávaný iba s OPALovým difúzorom

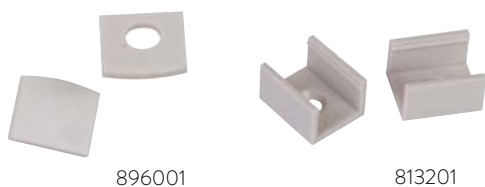

Doplňky

kód	názov	farba
896001	KONC-XC35-PL	koncovka pre XC35 - plastová - nasúvacia
813201	KLIP-XC35	klip pre profily XC36

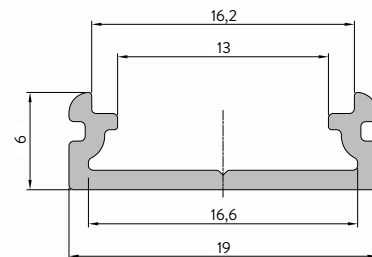
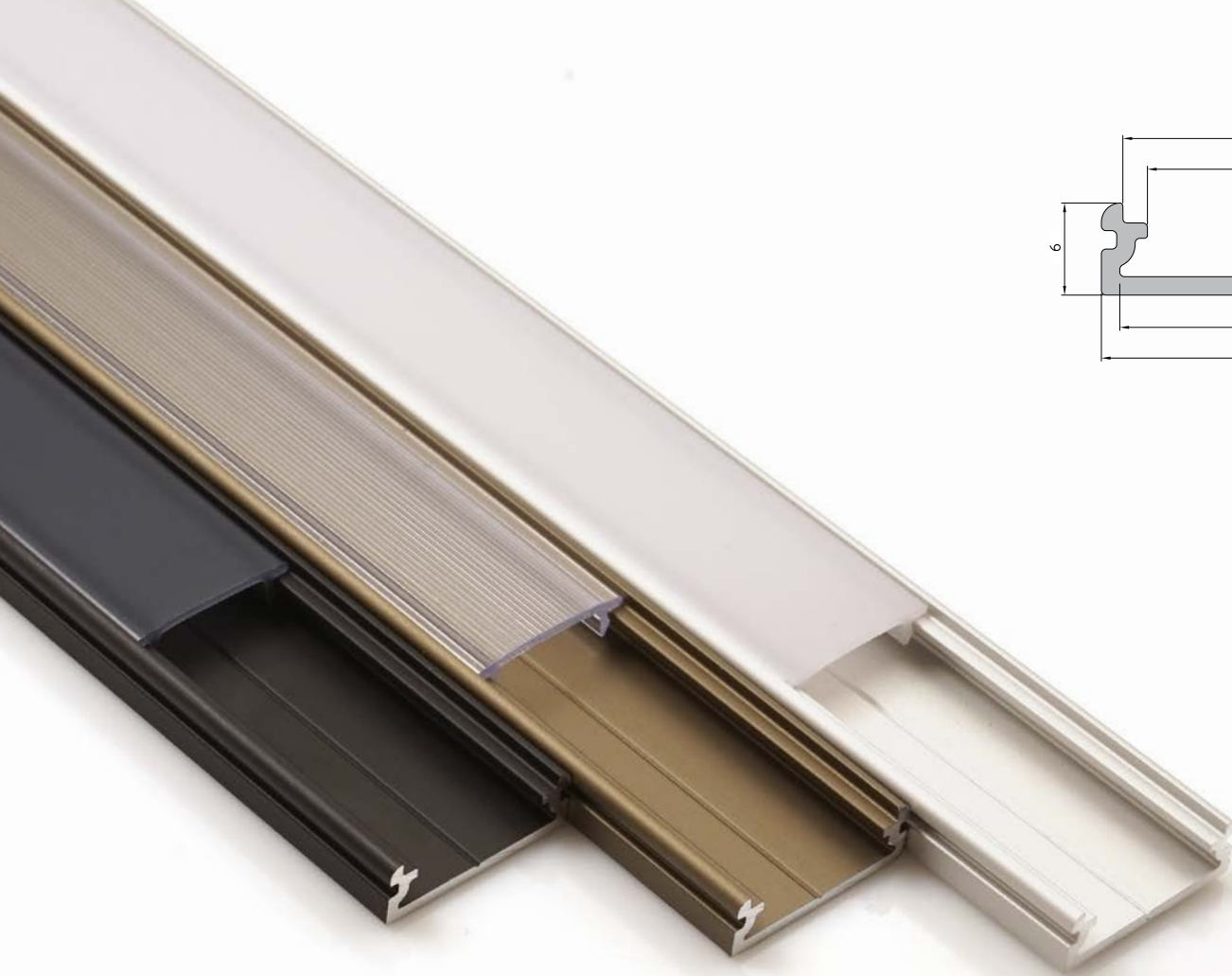

Tolerancie rozmerov podľa
EN 755-9

XC36

kód	názov	farba	max dĺžka (mm)	šírka (mm)	výška (mm)
84301	XC36	strieborný CO	4000	19	6
84302	BC36	bronzový C33	4000	19	6
84308	CC36	čierny C35	4000	19	6

■ povrchový profil

Difúzory

PC-N16-X-TRANSPARENT / OPAL
PC-N16-TRANSPARENT / OPAL

Doplňky



87502

kód	názov	farba
87502	KONC-XC36	koncovka pre XC36 - zliatinová - nasúvacia

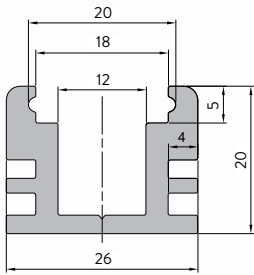

Tolerancie rozmerov podľa
EN 755-9

PC-P17-OPAL

POCHÔDZNY
DIFÚZOR



IP68
POLYURETÁNOVÁ
ŽIVICA

XC37



kód	názov	farba	max dĺžka (mm)	šírka (mm)	výška (mm)
837001	XC37	strieborný CO	4000	26	20

■ povrchový profil

Difúzory

PC-P17-OPAL

IP68 PREVEDENIE

Zaliatie polyuretánovou živcou v OPAL / TRANSPARENT prevedení

Doplňky

kód	názov	farba
890037	KONC-PL3D-XC37	koncovka pre XC37 - plastová - nasúvacia



890037

XP15

kód	názov	farba	max dĺžka (mm)	šírka (mm)	výška (mm)
82401	XP15	strieborný CO	4000	15	2

■ plochý profil

XP25

kód	názov	farba	max dĺžka (mm)	šírka (mm)	výška (mm)
82501	XP25	strieborný CO	4000	25	2
82508	CP25	čierny CC	4000	25	2

■ plochý profil

XP46

kód	názov	farba	max dĺžka (mm)	šírka (mm)	výška (mm)
82901	XP46	strieborný CO	4000	46	2
82908	CP46	čierny C35	4000	46	2

■ plochý profil

XP21

kód	názov	farba	max dĺžka (mm)	šírka (mm)	výška (mm)
81501	XP21	strieborný CO	4000	11	60
81508	CP21	čierny C35	4000	11	60

■ soklová lišta



Difúzory pre ALU profily

Pre naše ALU profily máme v ponuke difúzory, ktoré sú všetky na nakliknutie, čím je zabezpečená jednoduchšia montáž.

Všetky difúzory sú vyrobené z kvalitného POLYCARBONATU alebo PMMA plastu, ktoré sú UV stabilné a antistatické. Difúzory máme v prevedení transparent, opál, satín, microprismatický plast s UGR<19 a novinkou je dizajnový difúzor v prevedení BLACK.

PC-N14-X

kód	názov	popis	max dĺžka (mm)
88702	PC-N14X-C	PC - difúzor transparent	2000
88706	PC-N14X-O	PC - difúzor opal	2000

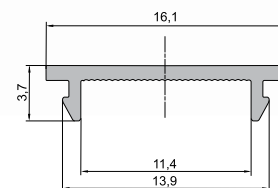
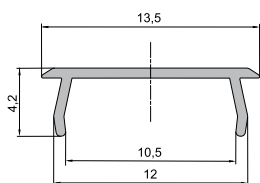

PC-N16-X

kód	názov	popis	max dĺžka (mm)
89702	PC-N16X-C	PC - difúzor transparent	2000
89706	PC-N16X-O	PC - difúzor opal	2000

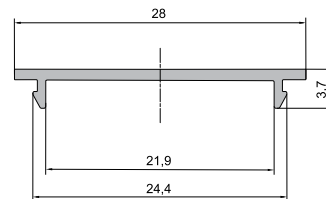

PC-N28-X

kód	název	popis		max délka (mm)
90702	PC-N28X-C	PC - difúzor	transparent	2000
90706	PC-N28X-O	PC - difúzor	opal	2000

kód	název	popis		max délka (mm)
811005	PC-N11-O	narážací polycarbonat	opal	4000

PC-N11-O

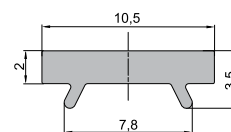
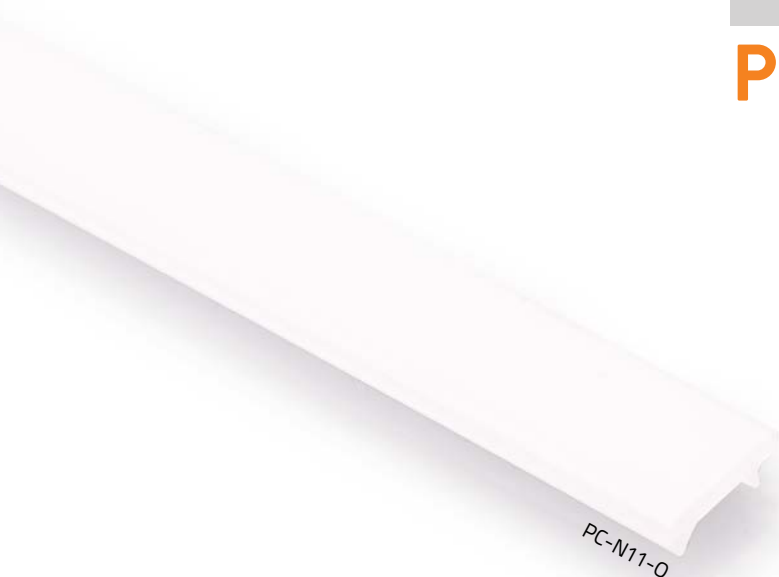

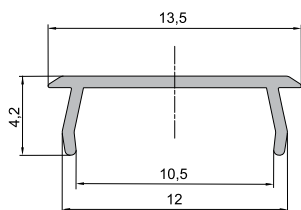

PC-N14

kód	název	popis		max délka (mm)
88704	PC-N14-C	PC - difúzor	transparent	4000
88705	PC-N14-O	PC - difúzor	opal	4000
88707	PC-N14-BLACK	PC - difúzor	black	4000

kód	název	popis		max délka (mm)
89704	PC-N16-C	PC - difúzor	transparent	4000
89705	PC-N16-O	PC - difúzor	opal	4000
89707	PC-N16-BLACK	PC - difúzor	black	4000

PC-N16

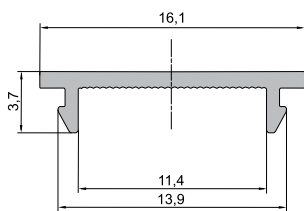

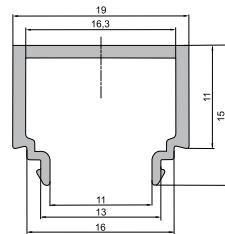

PC-S16-O

kód	název	popis	max délka (mm)
89709	PC-S16-O	PC - difúzor opal	4000

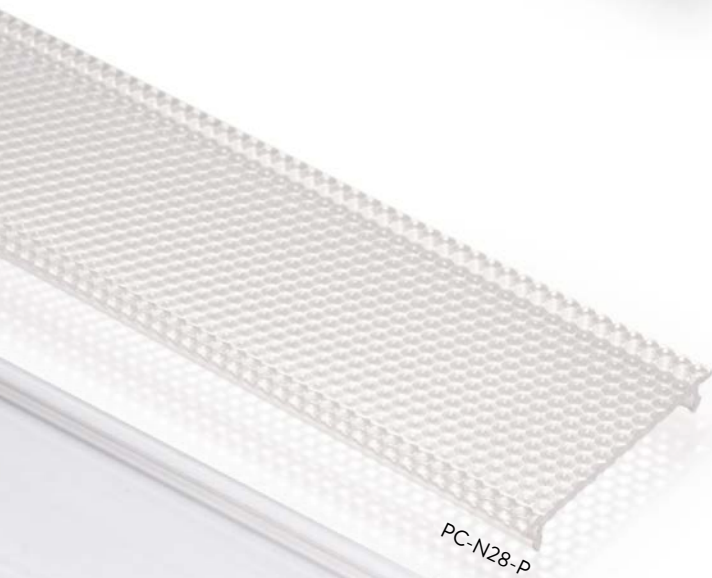

kód	název	popis	max délka (mm)
89504	PC-N28-C	PC - difúzor transparent	4000
89505	PC-N28-O	PC - difúzor opal	4000
89506	PC-N28-P	PC - difúzor prisma	4000
89508	PC-N28-BLACK	PC - difúzor black	4000
89505	PC-S28-O	PC - difúzor opal	4000

PC-N28

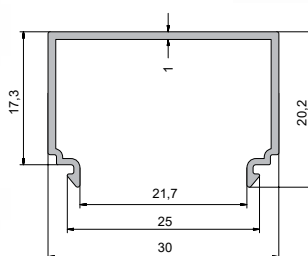
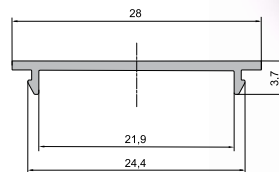

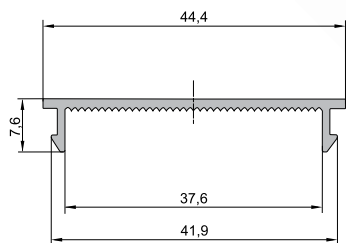

PC-N44

kód	název	popis	max délka (mm)
810004	PC-N44-C	PC - difúzor transparent	4000
810005	PC-N44-O	PC - difúzor opal	4000
810007	PC-N44-P	PC - difúzor prisma	4000

kód	název	popis	max délka (mm)
810007	PC-S44-O	PC - difúzor opal	4000

PC-S44-O

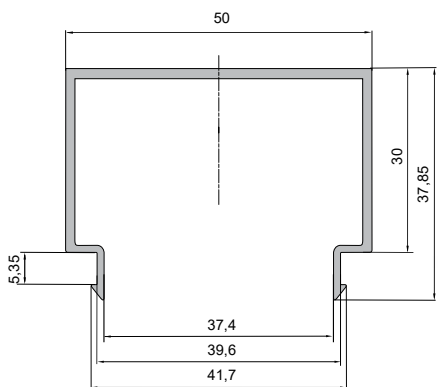



PC-K31

kód	název	popis		max délka (mm)
90605	PC-K31-O	PC - difúzor	opal	2000
90604	PC-K31-S	PC - difúzor	satin	2000



PC-S31

kód	název	popis		max délka (mm)
90705	PC-S31-O	PC - difúzor	opal	2000
90704	PC-S31-S	PC - difúzor	satin	2000

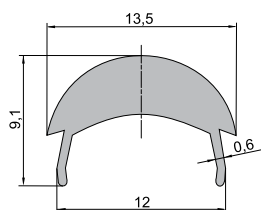

PC-N14-30°

kód	název	popis	max délka (mm)
88804	PC-N14-30°	optika 30° PMMA transparent	4000

kód	název	popis	max délka (mm)
89604	PC-K18-C	optika 110° PMMA transparent	2000
89605	PC-K18-O	optika 110° PMMA opal	2000
89606	PC-K18-S	optika 110° PMMA satin	2000

PC-K18

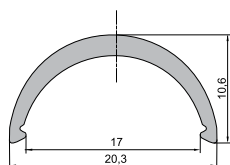

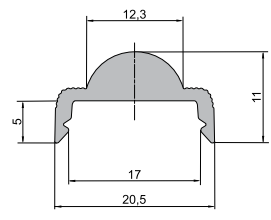

PC-30°

kód	název	popis		max délka (mm)
89004	PC-30°-C	optika 30° PMMA	transparent	2000
89005	PC-30°-S	optika 30° PMMA	satín	2000

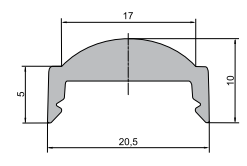

PC-60°

kód	název	popis		max délka (mm)
890004	PC-60°-C	optika 60° PMMA	transparent	2000
890005	PC-60°-S	optika 60° PMMA	satín	2000

KUFRÍK SO VZORKAMI PROFILOV



POZNÁMKY



LED LUMINO s.r.o.
Robotnícka 11591/1J
036 01 Martin
Slovakia

www.led-lumino.sk

0948 379 773

0918 599 330

obchod@led-lumino.sk